

GA-K8NF-9 (rev. 2.2)

AMD Socket 939 Processor Motherboard

User's Manual

Rev. 2201

12ME-K8NF9-2201R



* The WEEE marking on the product indicates this product must not be disposed of with user's other household waste and must be handed over to a designated collection point for the recycling of waste electrical and electronic equipment!!



* The WEEE marking applies only in European Union's member states.

Declaration of Conformity

G.B.T. Technology, Inc.
The Manufacturer/Importer
Ausehschlag Weg 41, P.O. 20327 Hamburg, Germany

(description of the apparatus, system, installation to which it refers)

GA-K8NF-9 (rev. 2.2)

Motherboard

(reference to the specification with which conformity is declared)
in conformity with CE marking
in accordance with 93/38 EEC EMC Directive

- | | | | |
|--|---|---|---|
| <input type="checkbox"/> EN 55011 | Limits and methods of measurement of radio disturbance characteristics of industrial, scientific and medical (ISM) high frequency equipment | <input checked="" type="checkbox"/> EN 61000-3-2 | Disturbances in supply systems caused by household appliances and similar electrical equipment. Voltage fluctuations* |
| <input type="checkbox"/> EN 55013 | Limits and methods of measurement of radio disturbance characteristics of equipment | <input checked="" type="checkbox"/> EN 55024 | Information Technology equipment |
| <input type="checkbox"/> EN 55014-1 | Limits and methods of measurement of radio disturbance characteristics of portable tools and similar electrical apparatus | <input type="checkbox"/> EN 55082-1 | Generic immunity standard Part 1: Residential, commercial and light industry |
| <input type="checkbox"/> EN 55015 | Limits and methods of measurement of radio disturbance characteristics of fluorescent lamps and luminaires | <input type="checkbox"/> EN 55082-2 | Generic immunity standard Part 2: Industrial environment |
| <input type="checkbox"/> EN 55020 | Immunity from radio interference of equipment | <input type="checkbox"/> EN 55014-2 | Immunity requirements for household appliances tools and similar apparatus |
| <input checked="" type="checkbox"/> EN 55022 | Limits and methods of measurement of radio disturbance characteristics of information technology equipment | <input type="checkbox"/> EN 50091-2 | EMC requirements for uninterruptible power systems (UPS) |
| <input type="checkbox"/> EN VDE 0855 | Cabled distribution systems. Equipment | | |
| <input type="checkbox"/> EN 50171 | Power supply systems for television sound and television signals | | |
| <input checked="" type="checkbox"/> CE marking | |  | (EC conformity marking) |
| <input type="checkbox"/> EN 60085 | Safety requirements for mains operated household and similar general use | <input type="checkbox"/> EN 60950 | Safety for information technology equipment including electrical business equipment |
| <input type="checkbox"/> EN 60335 | Safety of household and similar electrical appliances | <input type="checkbox"/> EN 50091-1 | General and Safety requirements for uninterruptible power systems (UPS) |

The manufacturer/ importer declares the conformity of above mentioned product with the actual required safety standards in accordance with LVD 73/23 EEC

Manufacturer/Importer

Signature: Timmy Huang

Date: Jan. 26, 2006

Name: Timmy Huang

(Stamp)

DECLARATION OF CONFORMITY

Per FCC Part 2 Section 2.1077(a)



Responsible Party Name: G.B.T. INC. (U.S.A.)

Address: 17358 Railroad Street

City of Industry, CA 91748

Phone/Fax No: (818) 854-9338 / (818) 854-9339

hereby declares that the product

Product Name: Motherboard

Model Number: GA-K8NF-9 (rev. 2.2)

Conforms to the following specifications:

FCC Part 15, Subpart B, Section 15.107(a) and Section 15.109

(a), Class B Digital Device

Supplementary Information:

This device complies with part 15 of the FCC Rules. Operation is subject to the following two conditions: (1) This device may not cause harmful and (2) this device must accept any interference received, including that may cause undesired operation.

Representative Person's Name: ERIC LU

Signature: Eric Lu

Date: Jan 26, 2006

Copyright

© 2006 GIGA-BYTE TECHNOLOGY CO., LTD. All rights reserved.

The trademarks mentioned in the manual are legally registered to their respective companies.

Notice

The written content provided with this product is the property of Gigabyte.

No part of this manual may be reproduced, copied, translated, or transmitted in any form or by any means without Gigabyte's prior written permission. Specifications and features are subject to change without prior notice.

Product Manual Classification

In order to assist in the use of this product, Gigabyte has categorized the user manual in the following:

- For quick installation, please refer to the "Hardware Installation Guide" included with the product.
- For detailed product information and specifications, please carefully read the "Product User Manual".
- For detailed information related to Gigabyte's unique features, please go to the "Technology Guide" section on Gigabyte's website to read or download the information you need.

For more product details, please click onto Gigabyte's website at www.gigabyte.com.tw

Table of Contents

GA-K8NF-9(rev. 2.2) Motherboard Layout	6
Block Diagram	7
Chapter 1 Hardware Installation	9
1-1 Considerations Prior to Installation	9
1-2 Feature Summary	10
1-3 Installation of the CPU and Fan Heat Sink	12
1-3-1 Installation of the CPU	12
1-3-2 Installation of the Fan Heat Sink	13
1-4 Installation of Memory	14
1-5 Installation of Expansion Cards	16
1-6 I/O Back Panel Introduction	17
1-7 Connectors Introduction	18
Chapter 2 BIOS Setup	27
The Main Menu (For example: BIOS Ver. : D1)	28
2-1 Standard CMOS Features	30
2-2 Advanced BIOS Features	32
2-3 Integrated Peripherals	34
2-4 Power Management Setup	37
2-5 PnP/PCI Configurations	39
2-6 PC Health Status	40
2-7 MB Intelligent Tweaker(M.I.T.)	43
2-8 Top Performance	45
2-9 Load Optimized Defaults	45
2-10 Set Supervisor/User Password	46
2-11 Save & Exit Setup	47
2-12 Exit Without Saving	47

Chapter 3 Drivers Installation	49
3-1 Install Chipset Drivers	49
3-2 Software Application	50
3-3 Software Information	50
3-4 Hardware Information	51
3-5 Contact Us	51
 Chapter 4 Appendix	 53
4-1 Unique Software Utilities	53
4-1-1 EasyTune 5 Introduction	53
4-1-2 Xpress Recovery2 Introduction	54
4-1-3 Flash BIOS Method Introduction	56
4-1-4 Configuring SATA Hard Drive(s)	65
4-1-5 2- / 4- / 6- / 8- Channel Audio Function Introduction	79
4-2 Troubleshooting	83

GA-K8NF-9(rev. 2.2) Motherboard Layout

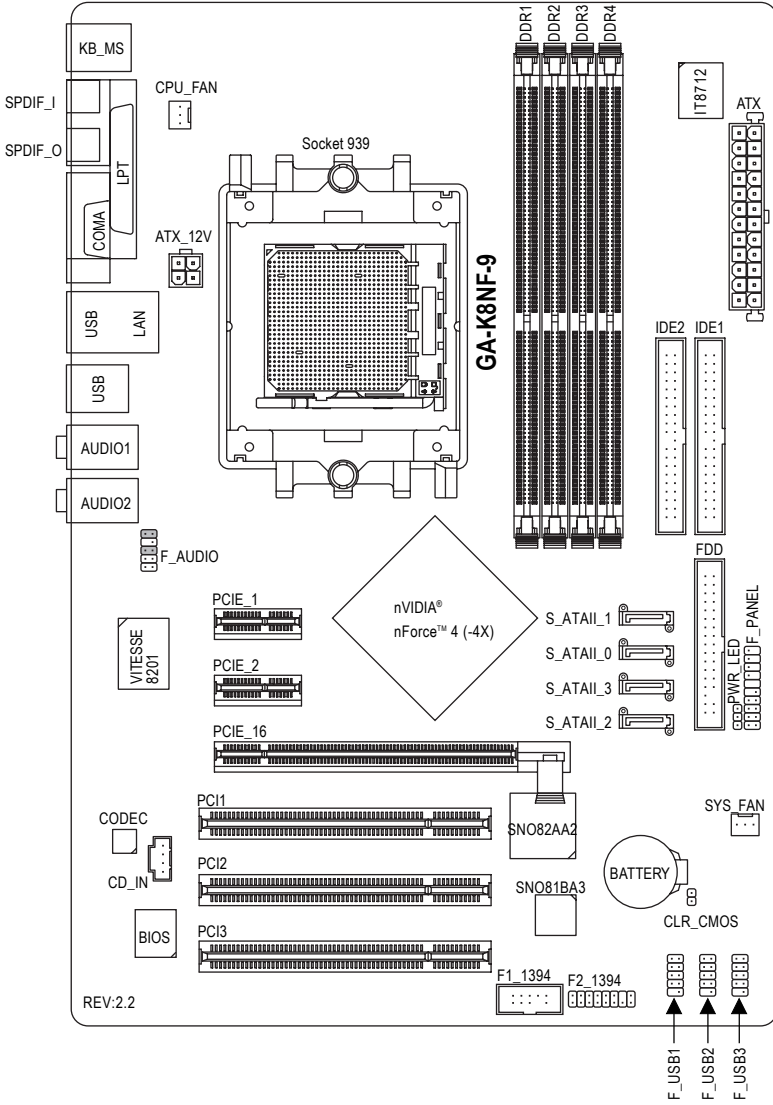

Chapter 1 Hardware Installation

1-1 Considerations Prior to Installation

Preparing Your Computer

The motherboard contains numerous delicate electronic circuits and components which can become damaged as a result of electrostatic discharge (ESD). Thus, prior to installation, please follow the instructions below:

1. Please turn off the computer and unplug its power cord.
2. When handling the motherboard, avoid touching any metal leads or connectors.
3. It is best to wear an electrostatic discharge (ESD) cuff when handling electronic components (CPU, RAM).
4. Prior to installing the electronic components, please have these items on top of an antistatic pad or within a electrostatic shielding container.
5. Please verify that the power supply is switched off before unplugging the power supply connector from the motherboard.

Installation Notices

1. Prior to installation, please do not remove the stickers on the motherboard. These stickers are required for warranty validation.
2. Prior to the installation of the motherboard or any hardware, please first carefully read the information in the provided manual.
3. Before using the product, please verify that all cables and power connectors are connected.
4. To prevent damage to the motherboard, please do not allow screws to come in contact with the motherboard circuit or its components.
5. Please make sure there are no leftover screws or metal components placed on the motherboard or within the computer casing.
6. Please do not place the computer system on an uneven surface.
7. Turning on the computer power during the installation process can lead to damage to system components as well as physical harm to the user.
8. If you are uncertain about any installation steps or have a problem related to the use of the product, please consult a certified computer technician.

Instances of Non-Warranty

1. Damage due to natural disaster, accident or human cause.
2. Damage as a result of violating the conditions recommended in the user manual.
3. Damage due to improper installation.
4. Damage due to use of uncertified components.
5. Damage due to use exceeding the permitted parameters.
6. Product determined to be an unofficial Gigabyte product.

1-2 Feature Summary

CPU	<ul style="list-style-type: none"> ◆ Socket 939 for AMD Sempron™ / Athlon™ 64 / Athlon™ 64 FX / Athlon™ 64 X2 Dual-Core processor (K8) ◆ Supports core frequencies in excess of 3000+ and faster
System Bus	◆ 1600MHz
Chipset	◆ nVIDIA® nForce4(-4X) chipset
LAN	◆ Onboard VITESSE 8201 phy (10/100/1000Mbit)
Audio	<ul style="list-style-type: none"> ◆ Onboard Realtek ALC850 chip ◆ Supports 2 / 4 / 6/ 8 channel audio ◆ Supports Jack Sensing (Connector Sensing) ◆ Supports SPDIF In/Out connection ◆ Supports CD In connection
Storage	<ul style="list-style-type: none"> ◆ nVIDIA® nForce4(-4X) chipset <ul style="list-style-type: none"> - 1 FDD connector, allowing connection of 2 FDD devices - 2 IDE connectors (IDE1, IDE2) with UDMA 33/ATA 66/ATA 100/ATA 133 support, allowing connection of 4 IDE devices - 4 SATA connectors (SATAII0_1, SATAII2_3), allowing connection of 4 SATA devices - Supports data striping (RAID 0), mirroring (RAID 1), striping + mirroring (RAID 0+1) for Serial ATA
O.S Support	◆ Microsoft Windows 2000/XP
Memory	<ul style="list-style-type: none"> ◆ 4 DDR DIMM memory slots (supports up to 4GB memory) ^(Note 1) ◆ Supports dual channel DDR 400/333/266/200 DIMMs ◆ Supports 2.5V DDR DIMMs
Expansion Slots	<ul style="list-style-type: none"> ◆ 1 PCI Express x 16 slot ◆ 2 PCI Express x 1 slots ◆ 3 PCI slots
Internal Connectors	<ul style="list-style-type: none"> ◆ 1 24-pin ATX power connector ◆ 1 4-pin ATX 12V power connector ◆ 1 floppy connector ◆ 2 IDE connectors ◆ 4 SATA 1.5Gb/s connectors ◆ 1 CPU fan connector ◆ 1 system fan connector ◆ 1 front panel connector ◆ 1 front audio connector ◆ 1 CD In connector ◆ 3 USB 2.0/1.1 connectors for additional 6 USB 2.0/1.1 ports by cables ◆ 2 IEEE1394b connectors for 3 additional IEEE1394 ports by cables ◆ 1 power LED connector

Rear Panel I/O	<ul style="list-style-type: none"> ◆ 1 PS/2 keyboard port ◆ 1 PS/2 mouse port ◆ 1 parallel port ◆ 1 SPDIF in port ◆ 1 SPDIF out port ◆ 1 serial port (COMA) ◆ 4 USB 2.0/1.1 ports ◆ 1 RJ-45 port ◆ 6 audio jacks (Line In / Line Out / MIC In / Surround Speaker Out (Rear Speaker Out) / Center/Subwoofer Speaker Out / Side Speaker Out)
I/O Control	<ul style="list-style-type: none"> ◆ IT8712 chip
Hardware Monitor	<ul style="list-style-type: none"> ◆ System voltage detection ◆ CPU temperature detection ◆ CPU / System fan speed detection ◆ CPU warning temperature ◆ CPU fan failure warning ◆ CPU smart fan control ^(Note 2)
BIOS	<ul style="list-style-type: none"> ◆ 1 4Mbit flash ROM ◆ Use of licensed AWARD BIOS
Additional Features	<ul style="list-style-type: none"> ◆ Supports @BIOS ◆ Supports Download Center ◆ Supports Q-Flash ◆ Supports EasyTune ^(Note 3) ◆ Supports Xpress Install ◆ Supports Xpress Recovery2 ◆ Supports Xpress Rescue
Bundle Software	<ul style="list-style-type: none"> ◆ Norton Internet Security (OEM version)
Form Factor	<ul style="list-style-type: none"> ◆ ATX form factor; 30.5cm x 21.0cm

(Note 1) Due to standard PC architecture, a certain amount of memory is reserved for system usage and therefore the actual memory size is less than the stated amount.

For example, 4 GB of memory size will instead be shown as 3.xxGB memory during system startup.

(Note 2) Whether the CPU Smart FAN Control function is supported will depend on the CPU you install.

For more detailed information please check at the FAQ section on GIGABYTE's website.

(Note 3) EasyTune functions may vary depending on different motherboards.

1-3 Installation of the CPU and Fan Heat Sink



Before installing the CPU, please comply with the following conditions:

1. Please make sure that the motherboard supports the CPU.
2. Please take note of the one indented corner of the CPU. If you install the CPU in the wrong direction, the CPU will not insert properly. If this occurs, please change the insert direction of the CPU.
3. Please add an even layer of heat sink paste between the CPU and heatsink.
4. Please make sure the heatsink is installed on the CPU prior to system use, otherwise overheating and permanent damage of the CPU may occur.
5. Please set the CPU host frequency in accordance with the processor specifications. It is not recommended that the system bus frequency be set beyond hardware specifications since it does not meet the required standards for the peripherals. If you wish to set the frequency beyond the proper specifications, please do so according to your hardware specifications including the CPU, graphics card, memory, hard drive, etc.

1-3-1 Installation of the CPU

Check the processor pins to see that none are bent. Move the socket lever to the unlocked position as shown in Figure 1.(90° to the plane of the motherboard) prior to inserting the processor. The pin 1 location is designated on the processor by a copper triangle that matches up to a triangle on the socket as shown in Figure 2. Align the processor to the socket and gently lower it into place. Do not force the processor into the socket.

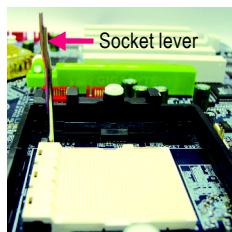

Fig.1

Position lever at a 90 degree angle.

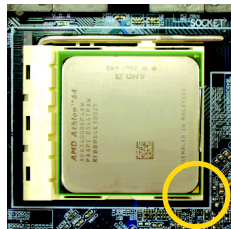

Fig.2

A gold-colored triangle is marked one edge of the CPU. Please align this edge with the socket edge closest to the CPU lever. Gently place the CPU into position making sure that the CPU pins fit perfectly into their holes.

Once the CPU is positioned into its socket, place one finger down on the middle of the CPU and gently press the metal lever back into its original position.



Please use extra care when installing the CPU. The CPU will not fit if positioned incorrectly. Rather than applying force, please change the positioning of the CPU.

1-3-2 Installation of the Fan Heat Sink

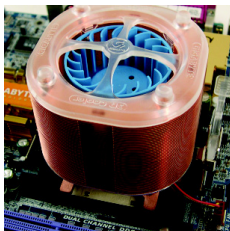

Fig.1

Before installing the heat sink, please first add an even layer of heat sink paste on the surface of the CPU. Install all the heat sink components (Please refer to the heat sink manual for detailed installation instructions).

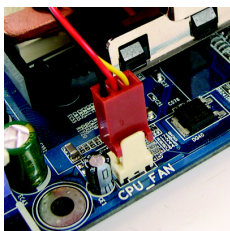

Fig.2

Please connect the heat sink power connector to the CPU_FAN connector located on the motherboard so that the heat sink can properly function to prevent CPU overheating.



NOTE

The heat sink may adhere to the CPU as a result of hardening of the heat sink paste. To prevent such an occurrence, it is suggested that either thermal tape rather than heat sink paste be used for heat dissipation or using extreme care when removing the heat sink.

1-4 Installation of Memory



Before installing the memory modules, please comply with the following conditions:

1. Please make sure that the memory used is supported by the motherboard. It is recommended that memory of similar capacity, specifications and brand be used.
2. Before installing or removing memory modules, please make sure that the computer power is switched off to prevent hardware damage.
3. Memory modules have a foolproof insertion design. A memory module can be installed in only one direction. If you are unable to insert the module, please switch the direction.

The motherboard supports DDR memory modules, whereby BIOS will automatically detect memory capacity and specifications. Memory modules are designed so that they can be inserted only in one direction. The memory capacity used can differ with each slot.

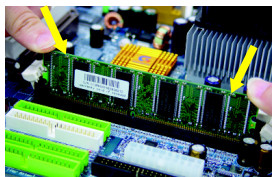
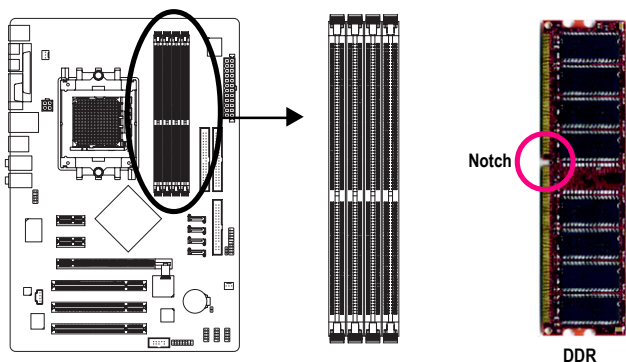

Fig.1

The DIMM socket has a notch, so the DIMM memory module can only fit in one direction. Insert the DIMM memory module vertically into the DIMM socket. Then push it down.



Fig.2

Close the plastic clip at both edges of the DIMM sockets to lock the DIMM module.

Reverse the installation steps when you wish to remove the DIMM module.

Dual Channel Memory Configuration

The GA-K8NF-9(rev. 2.2) supports the Dual Channel Technology. When the Dual Channel Technology is activated, the bandwidth of memory bus will be double the original one.

Due to CPU limitation, if you want to operate the Dual Channel Technology, please follow the guidelines below for Dual Channel memory configuration.

1. Dual Channel mode will not be enabled if only one DDR memory module is installed.
2. To enable Dual Channel mode with 2 memory modules (it is recommended to use memory modules of identical brand, size, chips, and speed), you must install them into DIMM sockets of the same color.
3. To enable Dual Channel mode with 4 memory modules, it is recommended to use memory modules of identical brand, size, chips, and speed.

The following is a Dual Channel Memory configuration table: (DS: Double Side, SS: Single Side)

	DDR1	DDR2	DDR3	DDR4
2 memory modules	DS/SS	DS/SS	X	X
	X	X	DS/SS	DS/SS
4 memory modules	DS/SS	DS/SS	DS/SS	DS/SS



NOTE

If two memory modules are to be used to achieve Dual Channel mode, we recommend installing them in DDR1 and DDR2 DIMM sockets.



CAUTION

All of the memory configurations below will cause system unable to boot.
(DS: Double Side, SS: Single Side)

	DDR1	DDR2	DDR3	DDR4
1 memory module	X	DS/SS	X	X
	X	X	X	DS/SS
2 memory modules	X	DS/SS	DS/SS	X
	DS/SS	X	X	DS/SS
	X	DS/SS	X	DS/SS
3 memory modules	DS/SS	DS/SS	DS/SS	X
	X	DS/SS	DS/SS	DS/SS
	DS/SS	X	DS/SS	DS/SS
	DS/SS	DS/SS	X	DS/SS

1-5 Installation of Expansion Cards

You can install your expansion card by following the steps outlined below:

1. Read the related expansion card's instruction document before install the expansion card into the computer.
2. Remove your computer's chassis cover, screws and slot bracket from the computer.
3. Press the expansion card firmly into expansion slot in motherboard.
4. Be sure the metal contacts on the card are indeed seated in the slot.
5. Replace the screw to secure the slot bracket of the expansion card.
6. Replace your computer's chassis cover.
7. Power on the computer, if necessary, setup BIOS utility of expansion card from BIOS.
8. Install related driver from the operating system.

Installing a PCI Express x 16 expansion card:

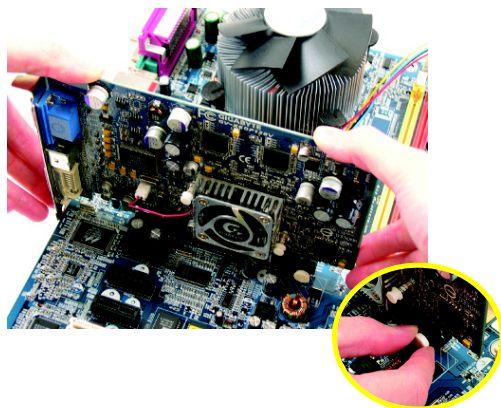

Please carefully pull out the small white-drawable bar at the end of the PCI Express x 16 slot when you try to install/uninstall the VGA card. Please align the VGA card to the onboard PCI Express x 16 slot and press firmly down on the slot. Make sure your VGA card is locked by the small white-drawable bar.

1-6 I/O Back Panel Introduction

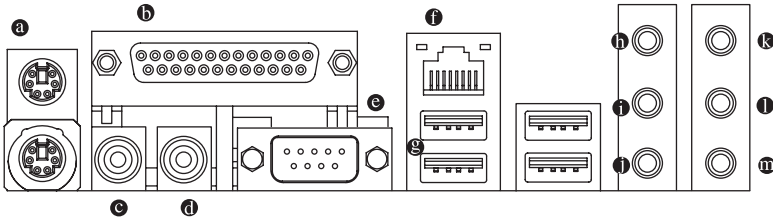

a PS/2 Keyboard and PS/2 Mouse Connector

To install a PS/2 port keyboard and mouse, plug the mouse to the upper port (green) and the keyboard to the lower port (purple).

b Parallel Port

The parallel port allows connection of a printer, scanner and other peripheral devices.

c SPDIF_I (SPDIF In)

Use SPDIF In feature only when your device has digital output function.

d SPDIF_O (SPDIF Out)

The SPDIF output is capable of providing digital audio to external speakers or compressed AC3 data to an external Dolby Digital Decoder.

e COMA (Serial Port)

Connects to serial-based mouse or data processing devices.

f LAN Port

The provided Internet connection is Gigabit Ethernet, providing data transfer speeds of 10/100/1000Mbps.

g USB port

Before you connect your device(s) into USB connector(s), please make sure your device(s) such as USB keyboard, mouse, scanner, zip, speaker...etc. have a standard USB interface. Also make sure your OS supports USB controller. If your OS does not support USB controller, please contact OS vendor for possible patch or driver upgrade. For more information please contact your OS or device(s) vendors.

h Line In

Devices like CD-ROM, walkman etc. can be connected to Line In jack.

i Line Out (Front Speaker Out)

Connect the stereo speakers, earphone or front surround speakers to this connector.

j MIC In

Microphone can be connected to MIC In jack.

k Center/Subwoofer Speaker Out

Connect the Center/Subwoofer speakers to this connector.

l Rear Speaker Out

Connect the rear surround speakers to this connector.

⑩ Side Speaker Out

Connect the side surround speakers to this connector.



You can use audio software to configure 2-/4-/6-/8-channel audio functioning.

1-7 Connectors Introduction

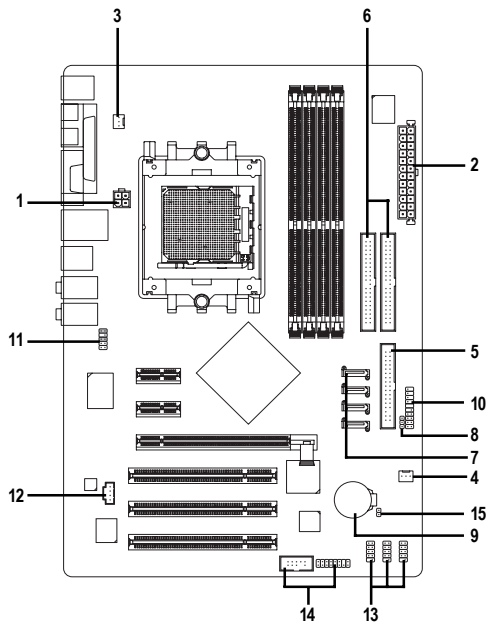

1) ATX_12V	9) BATTERY
2) ATX (Power Connector)	10) F_PANEL
3) CPU_FAN	11) F_AUDIO
4) SYS_FAN	12) CD_IN
5) FDD	13) F_USB1 / F_USB2 / F_USB3
6) IDE1 / IDE2	14) F1_1394 / F2_1394
7) SATAII0_1 / SATAII2_3	15) CLR_CMOS
8) PWR_LED	

1/2) ATX_12V/ATX (Power Connector)

With the use of the power connector, the power supply can supply enough stable power to all the components on the motherboard. Before connecting the power connector, please make sure that all components and devices are properly installed. Align the power connector with its proper location on the motherboard and connect tightly.

The ATX_12V power connector mainly supplies power to the CPU. If the ATX_12V power connector is not connected, the system will not start.

Caution!

Please use a power supply that is able to handle the system voltage requirements. It is recommended that a power supply that can withstand high power consumption be used (300W or greater). If a power supply is used that does not provide the required power, the result can lead to an unstable system or a system that is unable to start.

If you use a 24-pin ATX power supply, please remove the small cover on the power connector on the motherboard before plugging in the power cord; otherwise, please do not remove it.

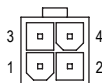
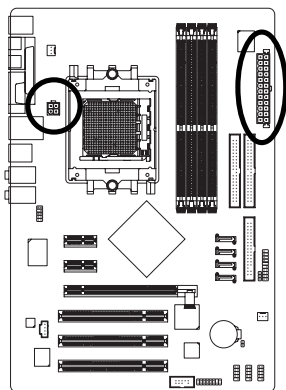

Pin No.	Definition
1	GND
2	GND
3	+12V
4	+12V

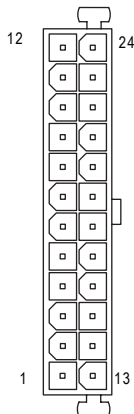

Pin No.	Definition
1	3.3V
2	3.3V
3	GND
4	+5V
5	GND
6	+5V
7	GND
8	Power Good
9	5V SB(stand by +5V)
10	+12V
11	+12V(Only for 24-pin ATX)
12	3.3V(Only for 24-pin ATX)
13	3.3V
14	-12V
15	GND
16	PS_ON(soft On/Off)
17	GND
18	GND
19	GND
20	-5V
21	+5V
22	+5V
23	+5V(Only for 24-pin ATX)
24	GND(Only for 24-pin ATX)

3/4) CPU_FAN / SYS_FAN (Cooler Fan Power Connector)

The cooler fan power connector supplies a +12V power voltage via a 3-pin power connector and possesses a foolproof connection design.

Most coolers are designed with color-coded power connector wires. A red power connector wire indicates a positive connection and requires a +12V power voltage. The black connector wire is the ground wire (GND).

Please remember to connect the power to the cooler to prevent system overheating and failure.

Caution!

Please remember to connect the power to the CPU fan to prevent CPU overheating and failure.

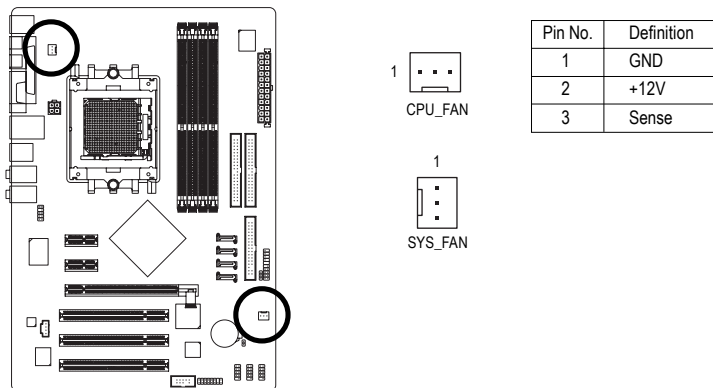

5) FDD (FDD Connector)

The FDD connector is used to connect the FDD cable while the other end of the cable connects to the FDD drive. The types of FDD drives supported are: 360KB, 720KB, 1.2MB, 1.44MB and 2.88MB.

Please connect the red power connector wire to the pin1 position.

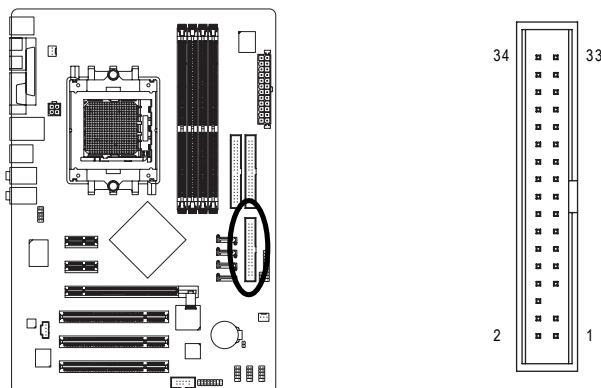

6) IDE1 / IDE2 (IDE Connector)

An IDE device connects to the computer via an IDE connector. One IDE connector can connect to one IDE cable, and the single IDE cable can then connect to two IDE devices (hard drive or optical drive). If you wish to connect two IDE devices, please set the jumper on one IDE device as Master and the other as Slave (for information on settings, please refer to the instructions located on the IDE device).

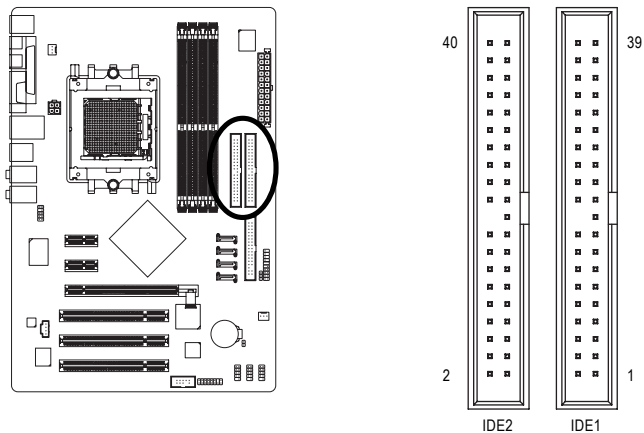

7) SATAII0_1 / SATAII2_3 (Serial ATA Connectors, Controlled by nForce4(-4X))

Serial ATA can provide up to 150MB/s transfer rate. Please refer to the BIOS setting for the Serial ATA and install the proper driver in order to work properly.

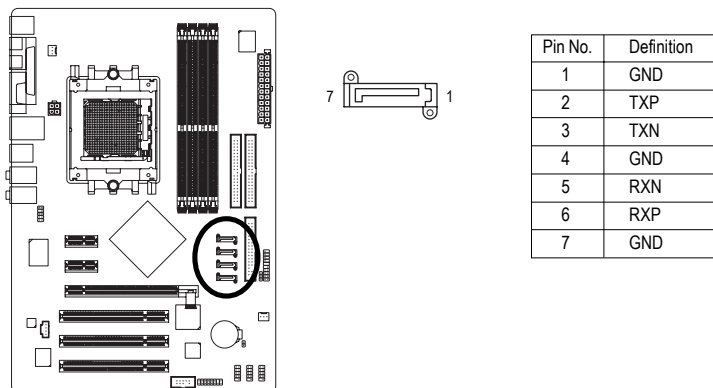

8) PWR_LED

PWR_LED is connect with the system power indicator to indicate whether the system is on/off. It will blink when the system enters suspend mode.

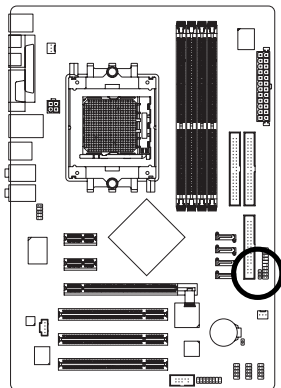

Pin No.	Definition
1	MPD+
2	MPD-
3	MPD-

9) BATTERY

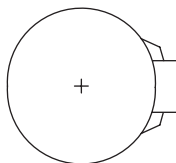
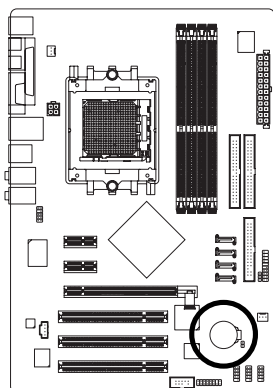

- ❖ Danger of explosion if battery is incorrectly replaced.
- ❖ Replace only with the same or equivalent type recommended by the manufacturer.
- ❖ Dispose of used batteries according to the manufacturer's instructions.

If you want to erase CMOS...

1. Turn off the computer and unplug the power cord.
2. Take out the battery gently and put it aside for about 10 minutes (Or you can use a metal object to connect the positive and negative pins in the battery holder to make them short for one minute).
3. Re-install the battery.
4. Plug the power cord and turn on the computer.

10) F_PANEL (Front Panel Jumper)

Please connect the power LED, PC speaker, reset switch and power switch etc. of your chassis to the F_PANEL connector according to the pin assignment below.

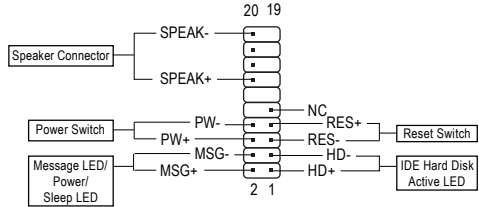
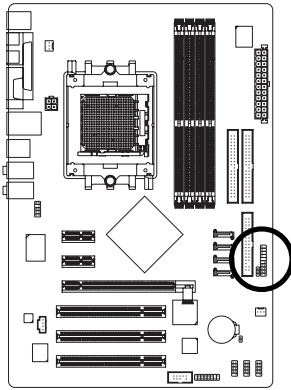

SPEAK (Speaker Connector) (Amber)	Pin 1: VCC(+) Pin 2- Pin 3: NC Pin 4: Data(-)
PW (Power Switch) (Red)	Open: Normal Operation Close: Power On/Off
MSG (Message LED/Power/Sleep LED) (Yellow)	Pin 1: LED anode(+) Pin 2: LED cathode(-)
RES (Reset Switch) (Green)	Open: Normal Operation Close: Reset Hardware System
HD (IDE Hard Disk Active LED) (Blue)	Pin 1: LED anode(+) Pin 2: LED cathode(-)
NC (Purple)	NC

11) F_AUDIO (Front Audio Panel Connector)

If you want to use Front Audio connector, you must remove 5-6, 9-10 Jumper.

In order to utilize the front audio header, your chassis must have front audio connector. Also please make sure the pin assignments for the cable are the same as the pin assignments for the front audio header. To find out if the chassis you are buying support front audio connector, please contact your dealer. Please note, you can have the alternative of using front audio connector or of using rear audio connector to play sound.

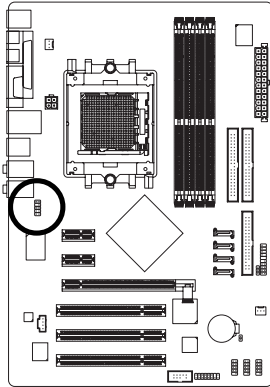

Pin No.	Definition
1	MIC
2	GND
3	MIC_BIAS
4	Power
5	FrontAudio(R)
6	Rear Audio(R)/Return R
7	NC
8	No Pin
9	FrontAudio(L)
10	Rear Audio(L)/Return L

12) CD_IN (CD In Connector)

Connect CD-ROM or DVD-ROM audio out to the connector.

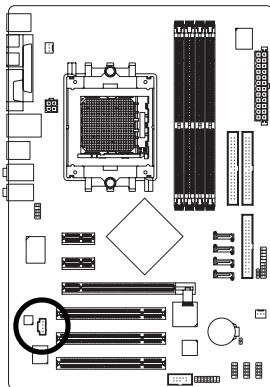

Pin No.	Definition
1	CD-L
2	GND
3	GND
4	CD-R

13) F_USB1 / F_USB2 / F_USB3 (Front USB Connector)

Be careful with the polarity of the front USB connector. Check the pin assignment carefully while you connect the front USB cable, incorrect connection between the cable and connector will make the device unable to work or even damage it. For optional front USB cable, please contact your local dealer.

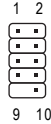
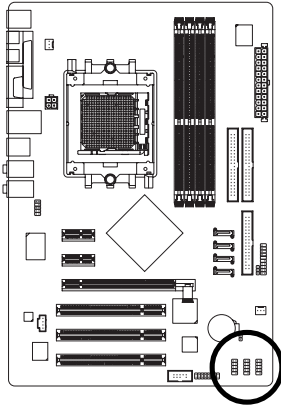

Pin No.	Definition
1	Power (5V)
2	Power (5V)
3	USB DX-
4	USB Dy-
5	USB DX+
6	USB Dy+
7	GND
8	GND
9	No Pin
10	NC

14) F1_1394 / F2_1394 (Front IEEE 1394 Connectors)

Serial interface set by Institute of Electrical and Electronics Engineers, which has features like high speed, high bandwidth and hot plug. Be careful with the polarity of the IEEE1394 connector. Check the pin assignment carefully while you connect the IEEE1394 cable, incorrect connection between the cable and connector will make the device unable to work or even damage it. For optional IEEE1394 cable, please contact your local dealer.

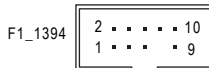
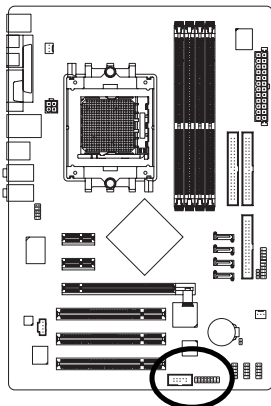

Pin No.	Definition
1	TPA0+
2	TPA0-
3	GND
4	GND
5	TPB0+
6	TPB0-
7	No Pin
8	Power(12V)
9	Power(12V)
10	GND

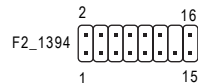



Pin No.	Definition
1	Power (12V)
2	Power (12V)
3	TPA1+
4	TPA1-
5	GND
6	GND
7	TPB1+
8	TPB1-
9	Power (12V)
10	Power (12V)
11	TPA2+
12	TPA2-
13	GND
14	No Pin
15	TPB2+
16	TPB2-

15) CLR_CMOS (Clear CMOS)

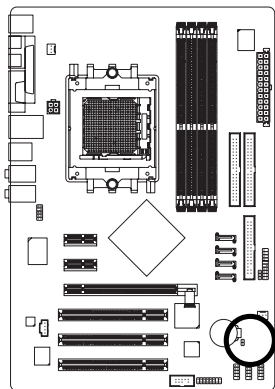
You may clear the CMOS data to its default values by this header. To clear CMOS, temporarily short 1-2 pin. Default doesn't include the jumper to prevent from improper use of this header.



1
 Open: Normal

1
 Short: Clear CMOS

Chapter 2 BIOS Setup

BIOS (Basic Input and Output System) includes a CMOS SETUP utility which allows user to configure required settings or to activate certain system features.

The CMOS SETUP saves the configuration in the CMOS SRAM of the motherboard.

When the power is turned off, the battery on the motherboard supplies the necessary power to the CMOS SRAM.

When the power is turned on, pushing the button during the BIOS POST (Power-On Self Test) will take you to the CMOS SETUP screen. You can enter the BIOS setup screen by pressing "Ctrl + F1".

When setting up BIOS for the first time, it is recommended that you save the current BIOS to a disk in the event that BIOS needs to be reset to its original settings. If you wish to upgrade to a new BIOS, either GIGABYTE's Q-Flash or @BIOS utility can be used.

Q-Flash allows the user to quickly and easily update or backup BIOS without entering the operating system. @BIOS is a Windows-based utility that does not require users to boot to DOS before upgrading BIOS but directly download and update BIOS from the Internet.

CONTROL KEYS

<↑> <↓> <←> <→>	Move to select item
<Enter>	Select Item
<Esc>	Main Menu - Quit and not save changes into CMOS Status Page Setup Menu and Option Page Setup Menu - Exit current page and return to Main Menu
<Page Up>	Increase the numeric value or make changes
<Page Down>	Decrease the numeric value or make changes
<F1>	General help, only for Status Page Setup Menu and Option Page Setup Menu
<F2>	Item Help
<F5>	Restore the previous CMOS value from CMOS, only for Option Page Setup Menu
<F7>	Load the Optimized Defaults
<F8>	Q-Flash utility
<F9>	System Information
<F10>	Save all the CMOS changes, only for Main Menu

Main Menu

The on-line description of the highlighted setup function is displayed at the bottom of the screen.

Status Page Setup Menu / Option Page Setup Menu

Press <F1> to pop up a small help window that describes the appropriate keys to use and the possible selections for the highlighted item. To exit the Help Window press <Esc>.



Because BIOS flashing is potentially risky, please do it with caution and avoid inadequate operation that may result in system malfunction.

<F12> : For Boot Menu

Select boot sequence for onboard (or add-on cards) device.

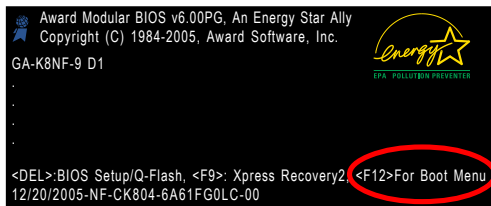

<F12> For Boot Menu

Use <↑> or <↓> to select a device, then press enter to accept . Press <ESC> to exit this menu.

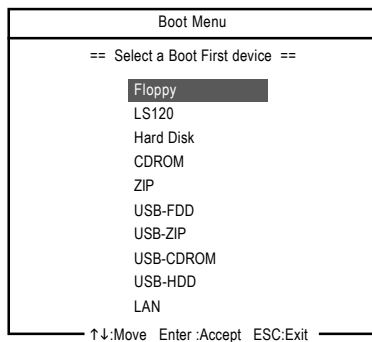

The Main Menu (For example: BIOS Ver. : D1)

Once you enter Award BIOS CMOS Setup Utility, the Main Menu (as figure below) will appear on the screen. Use arrow keys to select among the items and press <Enter> to accept or enter the sub-menu.

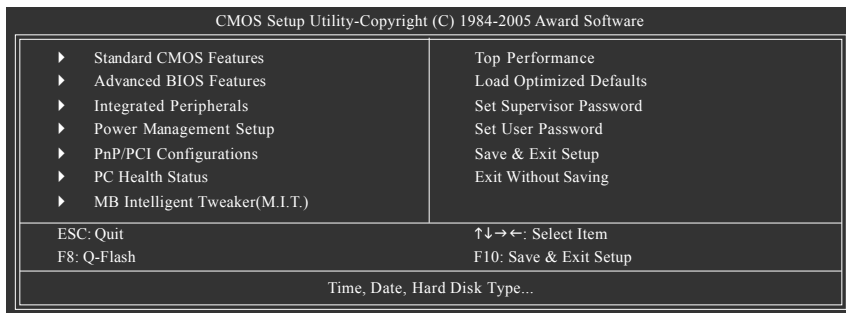

NOTE If you can't find the setting you want, please press "Ctrl+F1" to search the advanced option hidden.

Please Load Optimized Defaults in the BIOS when somehow the system works not stable as usual. This action makes the system reset to the default for stability.

The BIOS Setup menus described in this chapter are for reference only and may differ from the exact settings for your motherboard.

■ Standard CMOS Features

This setup page includes all the items in standard compatible BIOS.

■ Advanced BIOS Features

This setup page includes all the items of Award special enhanced features.

■ Integrated Peripherals

This setup page includes all onboard peripherals.

■ Power Management Setup

This setup page includes all the items of Green function features.

■ PnP/PCI Configuration

This setup page includes all the configurations of PCI & PnP ISA resources.

■ PC Health Status

This setup page is the System auto detect Temperature, voltage, fan, speed.

■ MB Intelligent Tweaker(M.I.T.)

This setup page is control CPU clock and frequency ratio.

■ Top Performance

If you wish to maximize the performance of your system, set "Top Performance" as "Enabled".

■ Load Optimized Defaults

Optimized Defaults indicates the value of the system parameters which the system would be in best performance configuration.

■ Set Supervisor Password

Change, set, or disable password. It allows you to limit access to the system and Setup, or just to Setup.

■ Set User Password

Change, set, or disable password. It allows you to limit access to the system.

■ Save & Exit Setup

Save CMOS value settings to CMOS and exit setup.

■ Exit Without Saving

Abandon all CMOS value changes and exit setup.

- ▶▶ Capacity Capacity of currently installed hard drive.
Hard drive information should be labeled on the outside drive casing. Enter the appropriate option based on this information.
- ▶▶ Cylinder Number of cylinders
- ▶▶ Head Number of heads
- ▶▶ Precomp Write precomp
- ▶▶ Landing Zone Landing zone
- ▶▶ Sector Number of sectors

☞ Drive A / Drive B

The category identifies the types of floppy disk drive A or drive B that has been installed in the computer.

- ▶▶ None No floppy drive installed
- ▶▶ 360K, 5.25" 5.25 inch PC-type standard drive; 360K byte capacity.
- ▶▶ 1.2M, 5.25" 5.25 inch AT-type high-density drive; 1.2M byte capacity
(3.5 inch when 3 Mode is Enabled).
- ▶▶ 720K, 3.5" 3.5 inch double-sided drive; 720K byte capacity
- ▶▶ 1.44M, 3.5" 3.5 inch double-sided drive; 1.44M byte capacity.
- ▶▶ 2.88M, 3.5" 3.5 inch double-sided drive; 2.88M byte capacity.

☞ Halt on

The category determines whether the computer will stop if an error is detected during power up.

- ▶▶ No Errors The system boot will not stop for any error that may be detected and you will be prompted.
- ▶▶ All Errors Whenever the BIOS detects a non-fatal error the system will be stopped.
- ▶▶ All, But Keyboard The system boot will not stop for a keyboard error; it will stop for all other errors. (Default value)
- ▶▶ All, But Diskette The system boot will not stop for a disk error; it will stop for all other errors.
- ▶▶ All, But Disk/Key The system boot will not stop for a keyboard or disk error; it will stop for all other errors.

☞ Floppy 3 Mode Support (for Japan Area)

- ▶▶ Disabled Normal Floppy Drive. (Default value)
- ▶▶ Drive A Drive A is 3 mode Floppy Drive.
- ▶▶ Drive B Drive B is 3 mode Floppy Drive.
- ▶▶ Both Drive A & B are 3 mode Floppy Drives.

2-2 Advanced BIOS Features

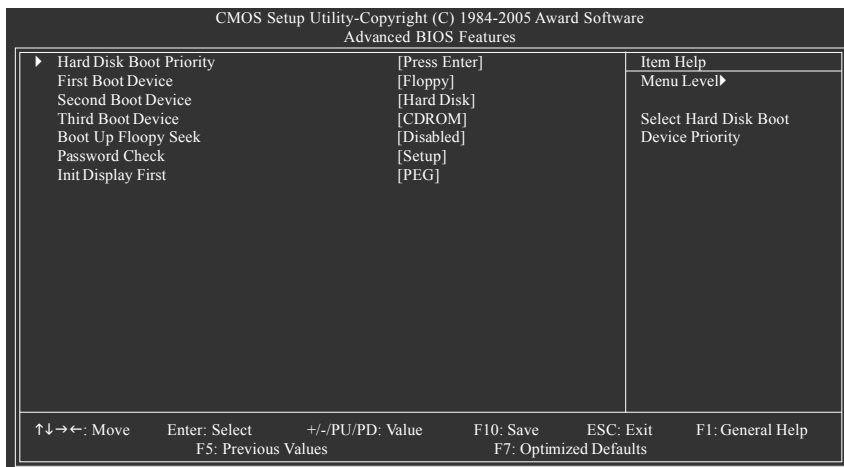

☞ Hard Disk Boot Priority

Select boot sequence for onboard(or add-on cards) SCSI, RAID, etc.

Use <↑> or <↓> to select a device, then press<+> to move it up, or <-> to move it down the list. Press <ESC> to exit this menu.

☞ First / Second / Third Boot Device

- ▶ Floppy Select your boot device priority by Floppy.
- ▶ LS120 Select your boot device priority by LS120.
- ▶ Hard Disk Select your boot device priority by Hard Disk.
- ▶ CDROM Select your boot device priority by CDROM.
- ▶ ZIP Select your boot device priority by ZIP.
- ▶ USB-FDD Select your boot device priority by USB-FDD.
- ▶ USB-ZIP Select your boot device priority by USB-ZIP.
- ▶ USB-CDROM Select your boot device priority by USB-CDROM.
- ▶ USB-HDD Select your boot device priority by USB-HDD.
- ▶ LAN Select your boot device priority by LAN.
- ▶ Disabled Disable this function.

☞ Boot Up Floppy Seek

During POST, BIOS will determine the floppy disk drive installed is 40 or 80 tracks. 360K type is 40 tracks 720K, 1.2M and 1.44M are all 80 tracks.

- ▶ Enabled BIOS searches for floppy disk drive to determine it is 40 or 80 tracks. Note that BIOS can not tell from 720K, 1.2M or 1.44M drive type as they are all 80 tracks.
- ▶ Disabled BIOS will not search for the type of floppy disk drive by track number. Note that there will not be any warning message if the drive installed is 360K. (Default value)

🔑 Password Check

- ▶▶ System The system can not boot and can not access to Setup page will be denied if the correct password is not entered at the prompt.
- ▶▶ Setup The system will boot, but access to Setup will be denied if the correct password is not entered at the prompt. (Default value)

🔑 Init Display First

This feature allows you to select the first initiation of the monitor display from which card when you install a PCI VGA card and a PCI Express VGA card on the motherboard.

- ▶▶ PCI slot Set Init display first to PCI.
- ▶▶ PEG Set Init display first to PCI Express VGA card. (Default value)

2-3 Integrated Peripherals

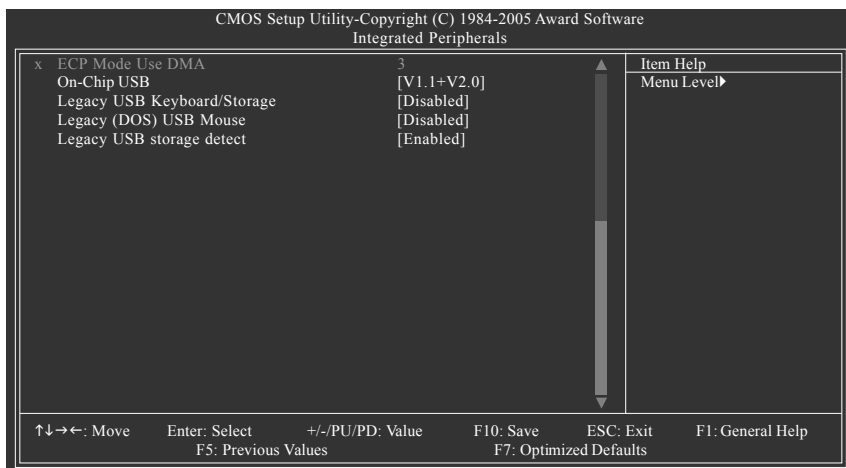
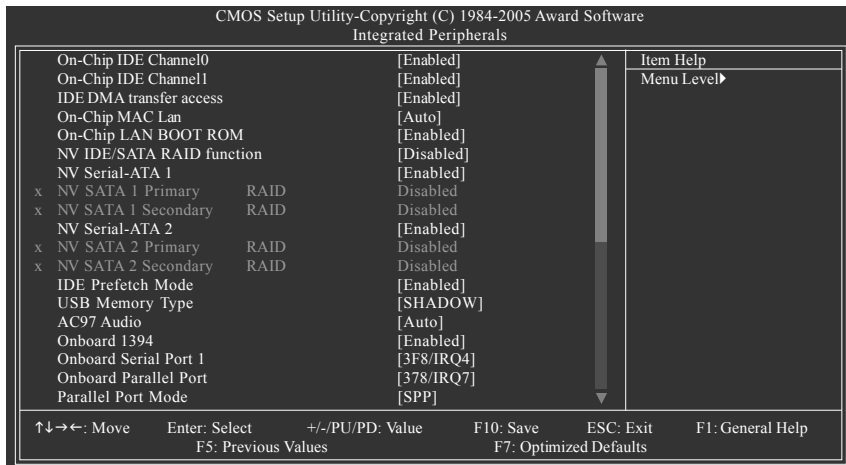

☞ On-Chip IDE Channel0

- ▶▶ Enabled Enable onboard 1st channel IDE port. (Default value)
- ▶▶ Disabled Disable onboard 1st channel IDE port.

☞ On-Chip IDE Channel1

- ▶▶ Enabled Enable onboard 2nd channel IDE port. (Default value)
- ▶▶ Disabled Disable onboard 2nd channel IDE port.

☞ IDE DMA transfer access

- ▶▶ Enabled Enable IDE DMA transfer access. (Default value)
- ▶▶ Disabled Disable this function.

- ☞ **On-Chip MAC Lan (controlled by VITESSE 8201 phy)**
 - ▶▶ Auto Auto-detect onboard LAN chip function. (Default value)
 - ▶▶ Disabled Disable onboard LAN chip function.
- ☞ **On-Chip LAN BOOT ROM**

This function decide whether to invoke the boot ROM of the onboard LAN chip.

 - ▶▶ Enabled Enable this function. (Default value)
 - ▶▶ Disabled Disable this function.
- ☞ **NV IDE/SATA RAID function**
 - ▶▶ Enabled Enable IDE/SATA RAID function.
 - ▶▶ Disabled Disable this function. (Default value)
- ☞ **NV Serial-ATA 1**
 - ▶▶ Enabled Enable Serial ATA 1 supported. (Default value)
 - ▶▶ Disabled Disable Serial ATA 1 supported.
- ☞ **NV SATA 1 Primary RAID**
 - ▶▶ Enabled Enable 1st SATA primary RAID function.
 - ▶▶ Disabled Disable this function. (Default value)
- ☞ **NV SATA 1 Secondary RAID**
 - ▶▶ Enabled Enable 1st SATA secondary RAID function.
 - ▶▶ Disabled Disable this function. (Default value)
- ☞ **NV Serial-ATA 2**
 - ▶▶ Enabled Enable Serial ATA 2 supported. (Default value)
 - ▶▶ Disabled Disable Serial ATA 2 supported.
- ☞ **NV SATA 2 Primary RAID**
 - ▶▶ Enabled Enable 2nd SATA primary RAID function.
 - ▶▶ Disabled Disable this function. (Default value)
- ☞ **NV SATA 2 Secondary RAID**
 - ▶▶ Enabled Enable 2nd SATA secondary RAID function.
 - ▶▶ Disabled Disable this function. (Default value)
- ☞ **IDE Prefetch Mode**
 - ▶▶ Enabled Enable IDE Prefetch mode. (Default value)
 - ▶▶ Disabled Disable IDE Prefetch mode.
- ☞ **USB Memory Type**
 - ▶▶ SHADOW Set USB memory type to SHADOW. (Default value)
 - ▶▶ Base Memory(640K)Set USB memory type to base memory(640K).
- ☞ **AC97 Audio**
 - ▶▶ Auto Enable onboard AC'97 audio function. (Default value)
 - ▶▶ Disabled Disable this function.
- ☞ **Onboard 1394**
 - ▶▶ Enabled Enable onboard IEEE1394 function. (Default value)
 - ▶▶ Disabled Disable onboard IEEE1394 function.

☞ Onboard Serial Port 1

- ▶▶ Auto BIOS will automatically setup the Serial port 1 address.
- ▶▶ 3F8/IRQ4 Enable onboard Serial port 1 and address is 3F8. (Default value)
- ▶▶ 2F8/IRQ3 Enable onboard Serial port 1 and address is 2F8.
- ▶▶ 3E8/IRQ4 Enable onboard Serial port 1 and address is 3E8.
- ▶▶ 2E8/IRQ3 Enable onboard Serial port 1 and address is 2E8.
- ▶▶ Disabled Disable onboard Serial port 1.

☞ Onboard Parallel Port

- ▶▶ Disabled Disable onboard LPT port.
- ▶▶ 378/IRQ7 Enable onboard LPT port and address is 378/IRQ7. (Default value)
- ▶▶ 278/IRQ5 Enable onboard LPT port and address is 278/IRQ5.
- ▶▶ 3BC/IRQ7 Enable onboard LPT port and address is 3BC/IRQ7.

☞ Parallel Port Mode

- ▶▶ SPP Using Parallel port as Standard Parallel Port. (Default value)
- ▶▶ EPP Using Parallel port as Enhanced Parallel Port.
- ▶▶ ECP Using Parallel port as Extended Capabilities Port.
- ▶▶ ECP+EPP Using Parallel port as ECP and EPP mode.

☞ ECP Mode Use DMA

- ▶▶ 3 Set ECP Mode Use DMA to 3. (Default value)
- ▶▶ 1 Set ECP Mode Use DMA to 1.

☞ On-Chip USB

- ▶▶ Disabled Disable this function if you are not using onboard USB function.
- ▶▶ V1.1+V2.0 Enable USB 1.1 and USB 2.0 controller. (Default value)
- ▶▶ V1.1 Enable only USB 1.1 controller.

☞ Legacy USB Keyboard/Storage

- ▶▶ Enabled Enable USB keyboard support in the MS-DOS environment.
- ▶▶ Disabled Disable this function. (Default value)

☞ Legacy (DOS) USB Mouse

- ▶▶ Enabled Enable USB mouse support in the MS-DOS environment.
- ▶▶ Disabled Disable this function. (Default value)

☞ Legacy USB storage detect

- ▶▶ Enabled Enable USB storage detect function. (Default value)
- ▶▶ Disabled Disable this function.

2-4 Power Management Setup

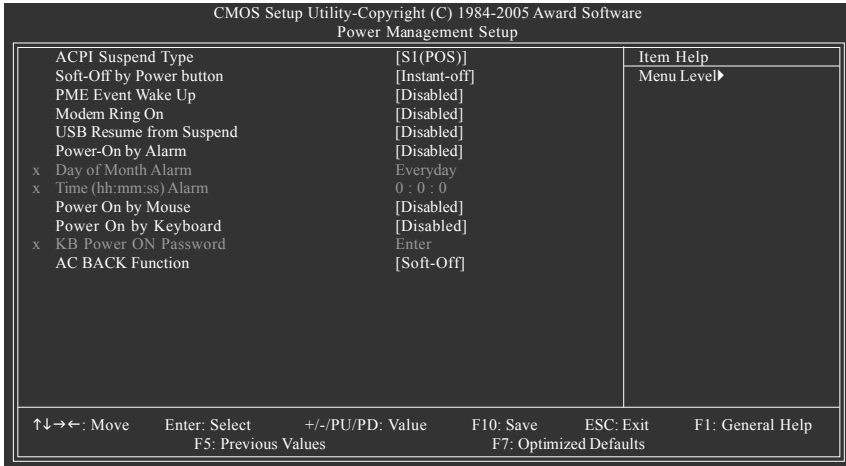

ACPI Suspend Type

- ▶▶ S1(POS) Set ACPI suspend type to S1/POS(Power On Suspend). (Default value)
- ▶▶ S3(STR) Set ACPI suspend type to S3/STR(Suspend To RAM).

Soft-Off by Power button

- ▶▶ Instant-off Press power button then Power off instantly. (Default value)
- ▶▶ Delay 4 Sec Press power button 4 seconds to Power off. Enter suspend if button is pressed less than 4 seconds.

PME Event Wake Up

This feature requires an ATX power supply that provides at least 1A on the 5VSB lead.

- ▶▶ Disabled Disable this function.
- ▶▶ Enabled Enable PME as wake up event. (Default value)

Modem Ring On

An incoming call via modem can awake the system from any suspend state.

- ▶▶ Disabled Disable Modem Ring on function. (Default value)
- ▶▶ Enabled Enable Modem Ring on function.

USB Resume from Suspend

- ▶▶ Disabled Disable this function. (Default value)
- ▶▶ Enable Enable USB device wake up system from suspend type.

Power-On by Alarm

You can set "Resume by Alarm" item to enabled and key in Date/Time to power on system.

- ▶▶ Disabled Disable this function. (Default value)
- ▶▶ Enabled Enable alarm function to POWER ON system.

If RTC Alarm Lead To Power On is Enabled.

- ▶▶ Day of Month Alarm : Everyday, 1~31
- ▶▶ Time (hh: mm: ss) Alarm : (0~23) : (0~59) : (0~59)

☞ **Power On by Mouse**

- ▶▶ Disabled Disabled this function. (Default value)
- ▶▶ Double Click Double click on PS/2 mouse left button to power on the system.

☞ **Power On by Keyboard**

- ▶▶ Disabled Disabled this function. (Default value)
- ▶▶ Password Enter from 1 to 5 characters to set the keyboard power on password.
- ▶▶ Any KEY Press any key to power on the system.
- ▶▶ Keyboard 98 If your keyboard have "POWER Key" button, you can press the key to power on the system.

☞ **KB Power ON Password**

When "Power On by Keyboard" set at Password, you can set the password here.

- ▶▶ Enter Input password(from 1 to 5 characters) and press Enter to set the password.

☞ **AC BACK Function**

- ▶▶ Soft-Off When AC-power back to the system, the system will be in "Off" state.
(Default value)
- ▶▶ Full-On When AC-power back to the system, the system always in "On" state.

2-5 PnP/PCI Configurations

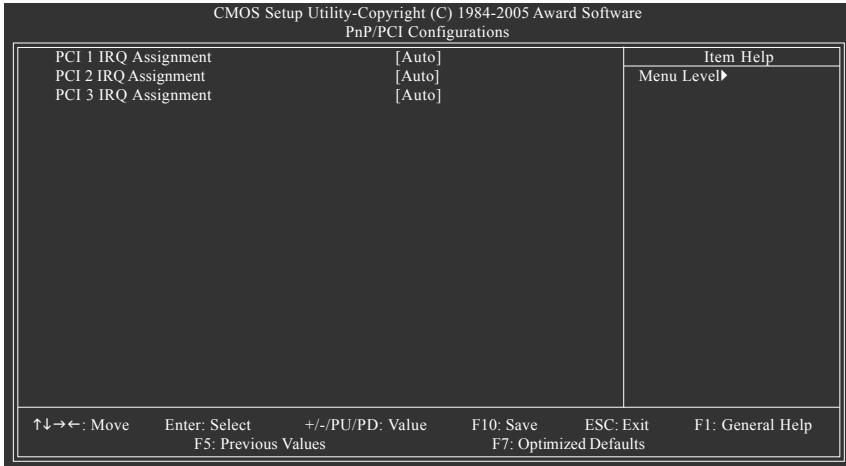

☞ PCI 1 IRQ Assignment

- ▶▶ Auto Auto assign IRQ to PCI 1. (Default value)
- ▶▶ 3,4,5,7,9,10,11,12,14,15 Set IRQ 3,4,5,7,9,10,11,12,14,15 to PCI 1.

☞ PCI 2 IRQ Assignment

- ▶▶ Auto Auto assign IRQ to PCI 2. (Default value)
- ▶▶ 3,4,5,7,9,10,11,12,14,15 Set IRQ 3,4,5,7,9,10,11,12,14,15 to PCI 2.

☞ PCI 3 IRQ Assignment

- ▶▶ Auto Auto assign IRQ to PCI 3. (Default value)
- ▶▶ 3,4,5,7,9,10,11,12,14,15 Set IRQ 3,4,5,7,9,10,11,12,14,15 to PCI 3.

☞ CPU Warning Temperature

- ▶▶ 60°C / 140°F Monitor CPU temperature at 60°C / 140°F.
- ▶▶ 70°C / 158°F Monitor CPU temperature at 70°C / 158°F.
- ▶▶ 80°C / 176°F Monitor CPU temperature at 80°C / 176°F.
- ▶▶ 90°C / 194°F Monitor CPU temperature at 90°C / 194°F.
- ▶▶ Disabled Disable this function. (Default value)

☞ CPU FAN Fail Warning

- ▶▶ Disabled Disable CPU fan fail warning function. (Default value)
- ▶▶ Enabled Enable CPU fan fail warning function.

☞ CPU Smart FAN Control ^(Note)

- ▶▶ Disabled Disable this function.
- ▶▶ Enabled When this function is enabled, CPU fan will run at different speed depending on CPU temperature. Users can adjust the fan speed with Easy Tune based on their requirements. (Default value)

☞ CPU FAN Manual Control

CPU Smart Fan Control will become disabled when this item is enabled.

- ▶▶ Enabled Enable the CPU fan manual control function.
- ▶▶ Disabled Disable the CPU fan manual control function. (Default value)

☞ CPU FAN: Low Speed

- ▶▶ Set the parameter of the CPU fan speed.

The CPU FAN: Low Speed option configures the speed of the CPU fan when the CPU temperature is below the temperature set in Temp Limit of Mid Speed. The parameter can be adjusted from 0~127. Higher parameter means faster CPU fan speed. (Default parameter: 8)

☞ CPU FAN: Mid Speed

- ▶▶ Set the parameter of the CPU fan speed.

The CPU FAN: Mid Speed option configures the speed of the CPU fan when the CPU temperature exceeds the temperature set in Temp Limit of Mid Speed. The parameter can be adjusted from 0~127. Higher parameter means faster CPU fan speed. (Default parameter: 12)

☞ CPU FAN: High Speed

- ▶▶ Set the parameter of the CPU fan speed.

The CPU FAN: High Speed option configures the speed of the CPU fan when the CPU temperature exceeds the temperature set in Temp Limit of High Speed. The parameter can be adjusted from 0~127. Higher parameter means faster CPU fan speed. (Default parameter: 80)

☞ Temp of FAN turn off (Default temperature: 0°C)

- ▶▶ When the CPU temperature is below the value set in this option, the CPU fan will stop spinning.

(Note) The CPU fan runs at full speed when both **CPU Smart FAN Control** and **CPU FAN Manual Control** are disabled.

Whether the CPU Smart FAN Control function is supported will depend on the CPU you install. For more detailed information please check at the FAQ section on GIGABYTE's website.

- ☞ **Temp Limit of Low Speed (Default temperature: 20°C)**
 - ▶▶ The CPU fan will stop spinning when the CPU temperature is below the value set in Temp of FAN turn off option. The CPU fan will start to spin again with the parameter set in CPU FAN: Low Speed when the CPU temperature exceeds the value set in Temp Limit of Low Speed.
- ☞ **Temp Limit of Mid Speed (Default temperature: 50°C)**
 - ▶▶ When the CPU temperature exceeds the value set in this option, the CPU fan spins with the parameter specified in CPU FAN: Mid Speed. For example, by default, when the CPU temperature exceeds 50°C, CPU fan runs with parameter 12.
- ☞ **Temp Limit of High Speed (Default temperature: 60°C)**
 - ▶▶ When the CPU temperature exceeds the value set in this option, the CPU fan rotates with the parameter specified in CPU FAN: High Speed. For example, by default, when the CPU temperature exceeds 60°C, CPU fan runs with parameter 80.
- ☞ **Temp of full FAN Speed (Default temperature: 70°C)**
 - ▶▶ When the CPU temperature exceeds the value set in this option, the CPU fan runs at full speed.

2-7 MB Intelligent Tweaker(M.I.T.)

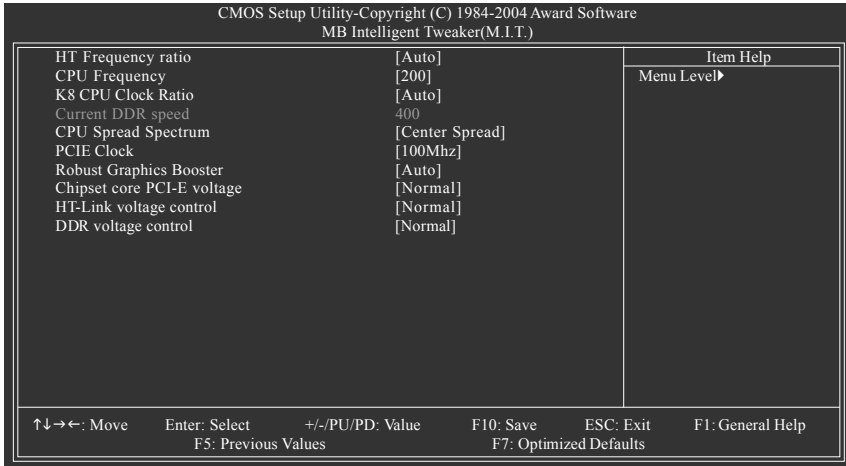

Incorrect using these features may cause your system broken. For power end-user use only.

- ☞ **HT Frequency Ratio**
This setup option will automatically assign by CPU detection. (Default value: **Auto**)
- ☞ **CPU Frequency**
▶▶ 200 ~ 456 Set CPU frequency from 200Mhz to 456Mhz.
- ☞ **K8 CPU Clock Ratio**
▶▶ This setup option will automatically assign by CPU detection. (Default value: **Auto**)
- ☞ **Current DDR speed**
▶▶ Display the current DDR speed.
- ☞ **CPU Spread Spectrum**
▶▶ Disabled Disable CPU Spread Spectrum.
▶▶ Center Spread Set CPU Spread Spectrum to Center Spread. (Default value)
- ☞ **PCIE Clock**
▶▶ 100Mhz ~ 150Mhz Set PCI-E clock from 100Mhz to 150Mhz.
- ☞ **Robust Graphics Booster**
Select the options can enhance the VGA graphics card bandwidth to get higher performance.
▶▶ Auto Set Robust Graphics Booster to Auto. (Default value)
▶▶ Fast Set Robust Graphics Booster to Fast.
▶▶ Turbo Set Robust Graphics Booster to Turbo.

☞ Chipset core PCI-E voltage

- ▶▶ Normal Set chipset core PCI-E voltage as Core Power required. (Default value)
- ▶▶ +0.1v Increase chipset core PCI-E voltage +0.1V.
- ▶▶ +0.2v Increase chipset core PCI-E voltage +0.2V.
- ▶▶ +0.3v Increase chipset core PCI-E voltage +0.3V.

☞ HT-Link voltage control

- ▶▶ Normal Supply HT-Link voltage as HT-Link required. (Default value)
- ▶▶ +0.1v Increase HT-Link voltage +0.1V.
- ▶▶ +0.2v Increase HT-Link voltage +0.2V.
- ▶▶ +0.3v Increase HT-Link voltage +0.2V.

☞ DDR voltage control

- ▶▶ Normal Supply DDR voltage as DDR required. (Default value)
- ▶▶ +0.1v Increase DDR voltage +0.1V.
- ▶▶ +0.2v Increase DDR voltage +0.2V.

2-8 Top Performance

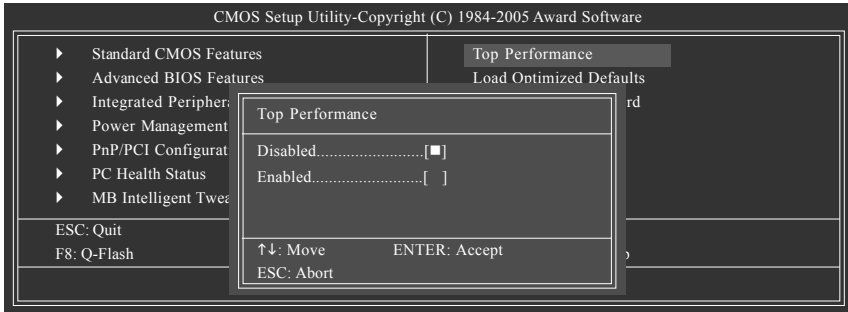

If you wish to maximize the performance of your system, set "Top Performance" as "Enabled".

- ▶▶ Disabled Disable this function. (Default Value)
- ▶▶ Enabled Enable Top Performance function.

"Top Performance" will increase hardware working speed. Different system configuration (both hardware component and OS) will effect the result. For example, the same hardware configuration might not run properly with Windows XP, but works smoothly with Windows NT. Therefore, if your system is not perform enough, the reliability or stability problem will appear sometimes, and we will recommend you disabling the option to avoid the problem as mentioned above.

2-9 Load Optimized Defaults

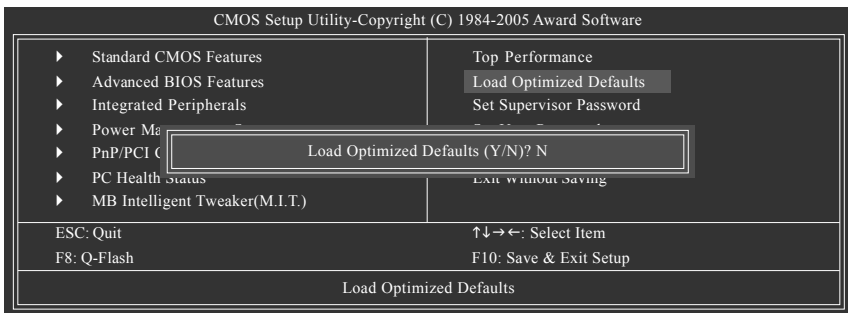

Selecting this field loads the factory defaults for BIOS and Chipset Features which the system automatically detects.

2-10 Set Supervisor/User Password

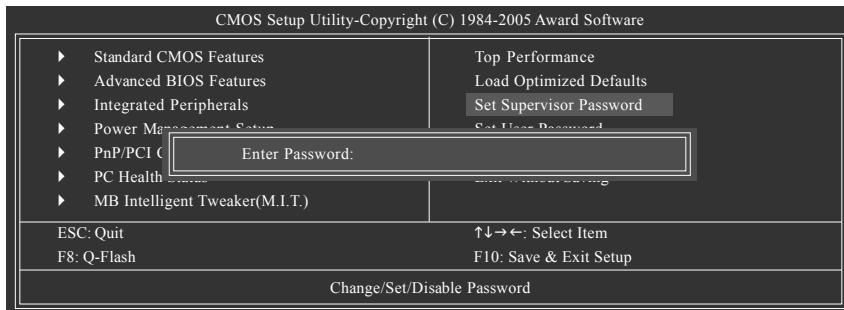

When you select this function, the following message will appear at the center of the screen to assist you in creating a password.

Type the password, up to eight characters, and press <Enter>. You will be asked to confirm the password. Type the password again and press <Enter>. You may also press <Esc> to abort the selection and not enter a password.

To disable password, just press <Enter> when you are prompted to enter password. A message "PASSWORD DISABLED" will appear to confirm the password being disabled. Once the password is disabled, the system will boot and you can enter Setup freely.

The BIOS Setup program allows you to specify two separate passwords:

SUPERVISOR PASSWORD and a USER PASSWORD. When disabled, anyone may access all BIOS Setup program function. When enabled, the Supervisor password is required for entering the BIOS Setup program and having full configuration fields, the User password is required to access only basic items.

If you select "System" at "Password Check" in Advance BIOS Features Menu, you will be prompted for the password every time the system is rebooted or any time you try to enter Setup Menu.

If you select "Setup" at "Password Check" in Advance BIOS Features Menu, you will be prompted only when you try to enter Setup.

2-11 Save & Exit Setup

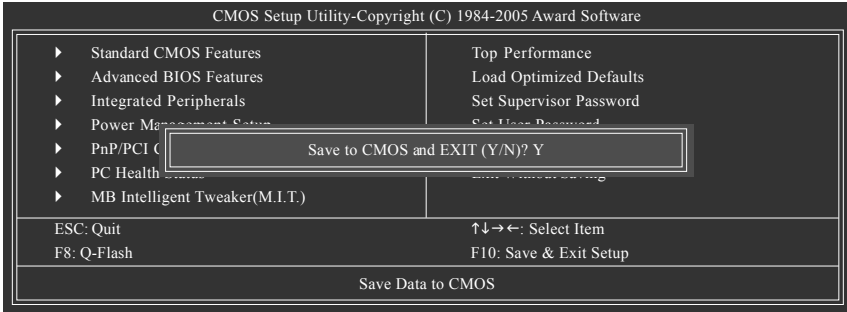

Type "Y" will quit the Setup Utility and save the user setup value to RTC CMOS.
Type "N" will return to Setup Utility.

2-12 Exit Without Saving

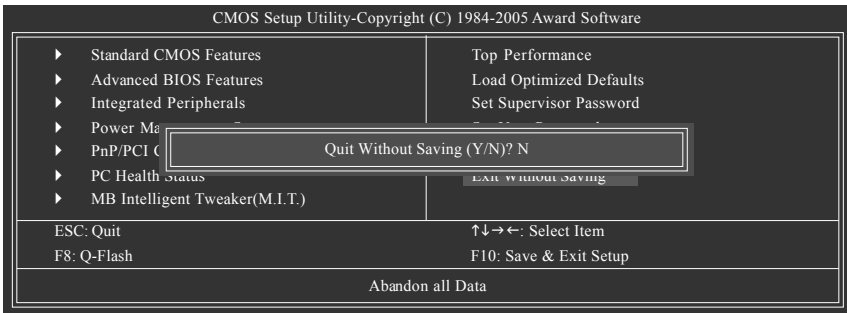

Type "Y" will quit the Setup Utility without saving to RTC CMOS.
Type "N" will return to Setup Utility.

Chapter 3 Drivers Installation



Pictures below are shown in Windows XP.

Insert the driver CD-title that came with your motherboard into your CD-ROM drive, the driver CD-title will auto start and show the installation guide. If not, please double click the CD-ROM device icon in "My computer", and execute the Setup.exe.

3-1 Install Chipset Drivers

After insert the driver CD, "Xpress Install" will scan automatically the system and then list all the drivers that recommended to install. The "Xpress Install" uses the "Click and Go" technology to install the drivers automatically. Just select the drivers you want then click the "GO" button. The "Xpress Install" will execute the installation for you automatically.

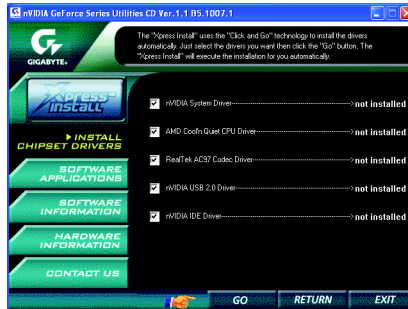

Some device drivers will restart your system automatically. After restarting your system the "Xpress Install" will continue to install other drivers.

System will reboot automatically after install the drivers, afterward you can install others application.



For USB2.0 driver support under Windows XP operating system, please use Windows Service Pack. After install Windows Service Pack, it will show a question mark "?" in "Universal Serial Bus controller" under "Device Manager". Please remove the question mark and restart the system (System will auto-detect the right USB2.0 driver).

3-2 Software Application

This page displays all the tools that GIGABYTE developed and some free software. You can click an item to install it.

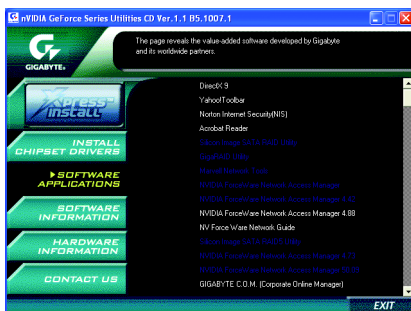

3-3 Software Information

This page lists the contents of software and drivers in this CD-title.

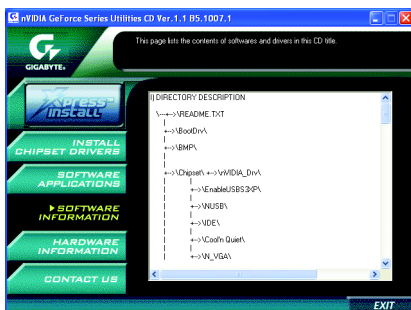

3-4 Hardware Information

This page lists all device you have for this motherboard.

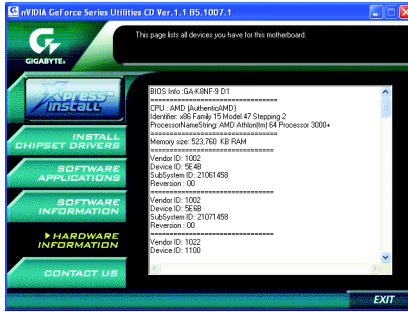

3-5 Contact Us

Please see the last page for details.



Chapter 4 Appendix

4-1 Unique Software Utilities

4-1-1 EasyTune 5 Introduction

EasyTune 5 presents the most convenient Windows based system performance enhancement and manageability utility. Featuring several powerful yet easy to use tools such as 1) Overclocking for enhancing system performance, 2) C.I.A. and M.I.B. for special enhancement for CPU and Memory, 3) Smart-Fan control for managing fan speed control of both CPU cooling fan and North-Bridge Chipset cooling fan, 4) PC health for monitoring system status. ^(Note)

User Interface Overview



	Button / Display	Description
1.	Overclocking	Enters the Overclocking setting page
2.	C.I.A./C.I.A.2 and M.I.B./M.I.B.2	Enters the C.I.A./2 and M.I.B./2 setting page
3.	Smart-Fan	Enters the Smart-Fan setting page
4.	PC Health	Enters the PC Health setting page
5.	GO	Confirmation and Execution button
6.	"Easy Mode" & "Advance Mode"	Toggles between Easy and Advance Mode
7.	Display screen	Display panel of CPU frequency
8.	Function display LEDs	Shows the current functions status
9.	GIGABYTE Logo	Log on to GIGABYTE website
10.	Help button	Display EasyTune™ 5 Help file
11.	Exit or Minimize button	Quit or Minimize EasyTune™ 5 software

(Note) EasyTune 5 functions may vary depending on different motherboards.

4-1-2 Xpress Recovery2 Introduction



Xpress Recovery2 is designed to provide quick backup and restoration of hard disk data. Supporting Microsoft operating systems including Windows XP/2000/NT/98/Me and DOS, and file systems including FAT16, FAT32, and NTFS, Xpress Recovery2 is able to back up data on hard disks on PATA and SATA IDE controllers. After Xpress Recovery2 is executed from CD-ROM for the first time, it will stay permanent in your hard disk. If you wish to run Xpress Recovery2 later, you can simply press F9 during system bootup to enter Xpress Recovery2 without the CD-ROM.

System requirements:

1. Intel x86 platforms
2. At least 64M bytes of system memory
3. VESA-supported VGA cards

How to use the Xpress Recovery2

Initial access by booting from CD-ROM and subsequent access by pressing the F9 key:

Steps: After entering BIOS Setup, go to **Advanced BIOS Feature** and set to boot from CD-ROM. Save the settings and exit the BIOS Setup. Insert the provided driver CD into your CD-ROM drive. Upon system restart, the message which says "Boot from CD/DVD:" will appear in the bottom left corner of the screen. Press any key to enter Xpress Recovery2.

After the steps above are completed, subsequent access to Xpress Recovery2 can be made by simply pressing the <F9> key during system power-on.



Boot from CD/DVD:

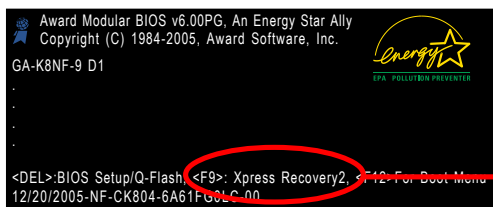

<F9> Xpress Recovery2



1. If you have already entered Xpress Recovery2 by booting from the CD-ROM, you can enter Xpress Recovery2 by pressing the <F9> key in the future.
2. System storage capacity and the reading/writing speed of the hard disk will affect the data backup speed.
3. It is recommended that Xpress Recovery2 be immediately installed once you complete installations of OS and all required drivers as well as software.

The Main Screen of Xpress Recovery2



1. RESTORE:

Restore the backed-up data to your hard disk. (This button will not appear if there is no backup file.)

2. BACKUP:

Back up data from hard disk.

3. REMOVE:

Remove previously-created backup files to release disk space. (This button will not appear if there is no backup file.)

4. REBOOT:

Limitations:

1. Not compatible to Xpress Recovery.
2. For the use of Xpress Recovery2, a primary partition must be reserved.
3. Xpress Recovery2 will store the backup file at the end of the hard disk, so free space available on the hard disk for the backup file must be allocated in advance. (A minimum 4GB is recommended but the actual space is dependent on the size of the data to be backed up)
4. Capable of backing up hard disks installed with Windows operating systems including DOS and Windows XP/2000/NT/9x/Me.
5. USB hard disks are currently not supported.
6. Does not support RAID/AHCI (class code 0104/0106) hard disks.
7. Capable of backing up and restoring only the first physical hard disk.

Hard disks detection sequence is as follows:

- a. PATA IDE primary channel
- b. PATA IDE secondary channel
- c. SATA IDE channel 1
- d. SATA IDE channel 2
- e. SATA IDE channel 3
- f. SATA IDE channel 4

Precautions:

1. When using hard disks with more than 128G under Windows 2000, be sure to execute the EnableBigLba.exe program from the driver CD before data backup.
2. It is normal that data backup takes longer time than data restoration.
3. Xpress Recovery2 is compliant with the GPL regulations.
4. On a few motherboards based on Nvidia chipsets, BIOS update is required for Xpress Recovery2 to correctly identify RAID and SATA IDE mode. Please contact your motherboard manufacturer.
5. Xpress Recovery2 supports only PATA hard disks and not SATA hard disks on the following motherboards (As this is a BIOS-related issue, it can be solved by BIOS update)

GA-K8U	GA-K8NXP-9	GA-8N-SLI Royal
GA-K8U-9	GA-K8N Ultra-9	GA-8N-SLI Pro
GA-K8NXP-SLI	GA-K8NF-9 (PCB Ver. 1.0)	GA-8N-SLI
GA-K8N Ultra-SLI	GA-K8NE (PCB Ver. 1.0)	
GA-K8N Pro-SLI	GA-K8NMF-9	

4-1-3 Flash BIOS Method Introduction



Method 1 : Q-Flash™ Utility

Q-Flash™ is a BIOS flash utility embedded in Flash ROM. With this utility, users only have to stay in the BIOS menu when they want to update BIOS. Q-Flash™ allows users to flash BIOS without any utility in DOS or

Windows. Using Q-Flash™ indicating no more fooling around with any complicated instructions and operating system since it is in the BIOS menu.



Please note that because updating BIOS has potential risk, please do it with caution!! We are sorry that Gigabyte Technology Co., Ltd is not responsible for damages of system because of incorrect manipulation of updating BIOS to avoid any claims from end-users.

Before You Begin:

Before you start updating BIOS with the Q-Flash™ utility, please follow the steps below first.

1. Download the latest BIOS for your motherboard from Gigabyte's website.
2. Extract the BIOS file downloaded and save the BIOS file (the one with model name.Fxx. For example, 8KNXP.U.Fba) to a floppy disk.
3. Reboot your PC and press **Del** to enter BIOS menu.

The BIOS upgrading guides below are separated into two parts.

If your motherboard has dual-BIOS, please refer to **Part One**.

If your motherboard has single-BIOS, please refer to **Part Two**.

Part One:

Updating BIOS with Q-Flash™ Utility on Dual BIOS Motherboards.

Some of Gigabyte motherboards are equipped with dual BIOS. In the BIOS menu of the motherboards supporting Q-Flash and Dual BIOS, the Q-Flash utility and Dual BIOS utility are combined in the same screen. This section only deals with how to use Q-Flash utility.

In the following sections, we take GA-8KNXP Ultra as the example to guide you how to flash BIOS from an older version to the latest version. For example, from Fa3 to Fba.

The BIOS file is Fa3
before updating

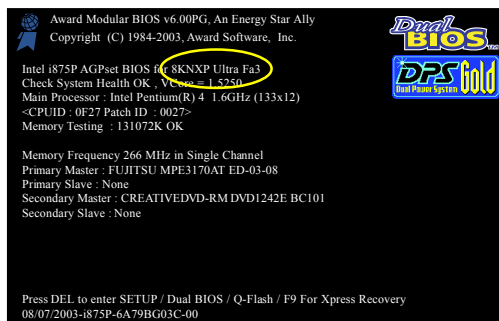

Entering the Q-Flash™ utility:

Step1: To use Q-Flash utility, you must press **Del** in the boot screen to enter BIOS menu.

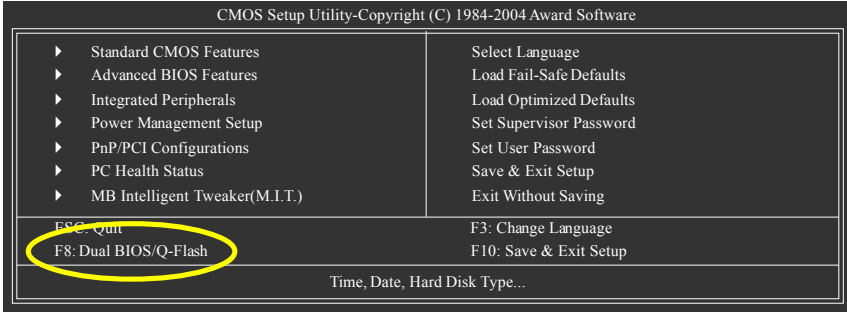

Step 2: Press **F8** button on your keyboard and then **Y** button to enter the Dual BIOS/Q-Flash utility.

Exploring the Q-Flash™ / Dual BIOS utility screen

The Q-Flash / Dual BIOS utility screen consists of the following key components.

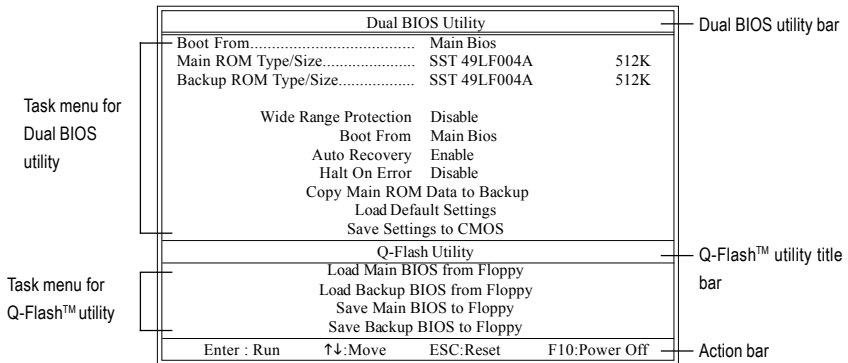

Task menu for Dual BIOS utility:

Contains the names of eight tasks and two item showing information about the BIOS ROM type. Blocking a task and pressing Enter key on your keyboard to enable execution of the task.

Task menu for Q-Flash utility:

Contains the names of four tasks. Blocking a task and pressing Enter key on your keyboard to enable execution of the task.

Action bar:

Contains the names of four actions needed to operate the Q-Flash/Dual BIOS utility. Pressing the buttons mentioned on your keyboards to perform these actions.

- Press Y button on your keyboard after you are sure to update BIOS. Then it will begin to update BIOS. The progress of updating BIOS will be displayed.



Please do not take out the floppy disk when it begins flashing BIOS.

- Press any keys to return to the Q-Flash menu when the BIOS updating procedure is completed.

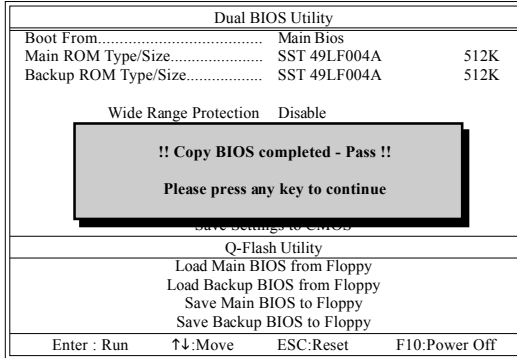

You can repeat Step 1 to 4 to flash the backup BIOS, too.

- Press Esc and then Y button to exit the Q-Flash utility. The computer will restart automatically after you exit Q-Flash.

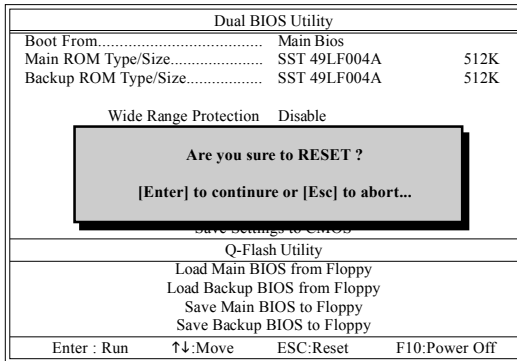

After system reboots, you may find the BIOS version on your boot screen becomes the one you flashed.

The BIOS file becomes Fba after updating.

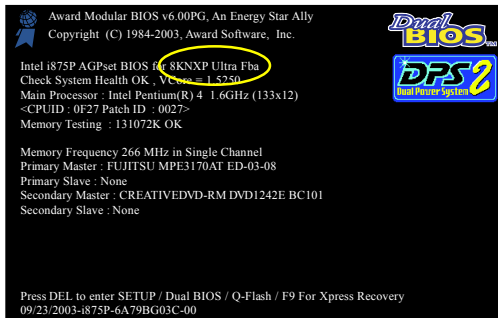

6. Press **Del** to enter BIOS menu after system reboots. When you are in BIOS menu, move to **Load Fail-Safe Defaults** item and press **Enter** to load BIOS Fail-Safe Defaults. Normally the system redetects all devices after BIOS has been upgraded. Therefore, we highly recommend reloading the BIOS defaults after BIOS has been upgraded.

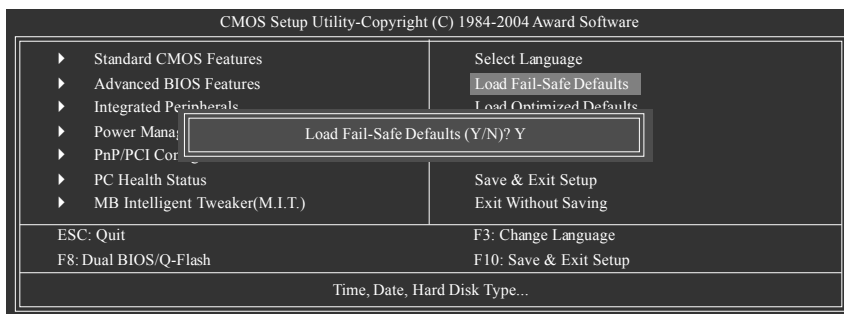

Press **Y** on your keyboard to load defaults.

7. Select **Save & Exit Setup** item to save the settings to CMOS and exit the BIOS menu. System will reboot after you exit the BIOS menu. The procedure is completed.

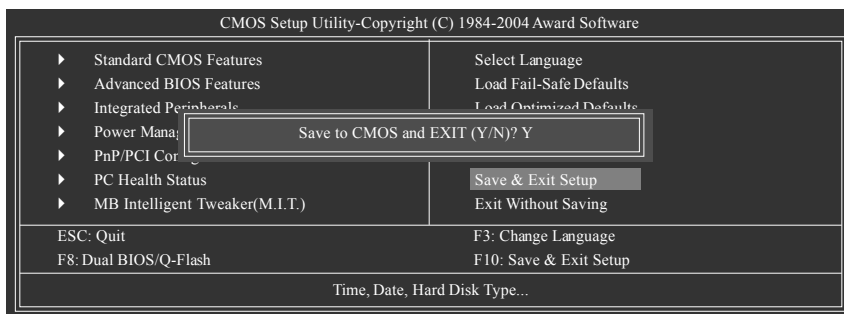

Press **Y** on your keyboard to save and exit.

Part Two:

Updating BIOS with Q-Flash™ Utility on Single-BIOS Motherboards.

This part guides users of single-BIOS motherboards how to update BIOS using the Q-Flash™ utility.

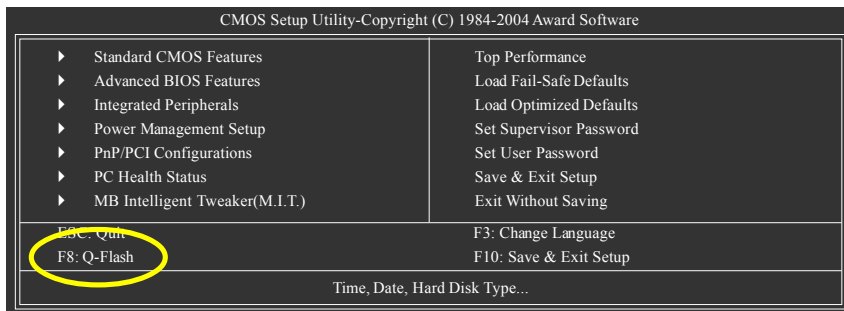

Exploring the Q-Flash™ utility screen

The Q-FlashBIOS utility screen consists of the following key components.

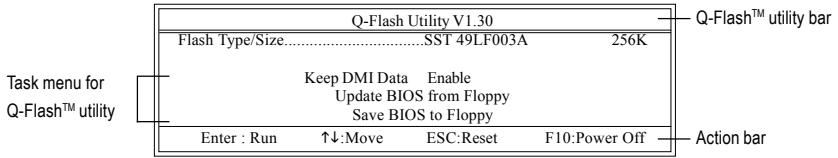

Task menu for Q-Flash utility:

Contains the names of three tasks. Blocking a task and pressing Enter key on your keyboard to enable execution of the task.

Action bar:

Contains the names of four actions needed to operate the Q-Flash utility. Pressing the buttons mentioned on your keyboards to perform these actions.

Using the Q-Flash™ utility:

This section tells you how to update BIOS using the Q-Flash utility. As described in the "Before you begin" section above, you must prepare a floppy disk having the BIOS file for your motherboard and insert it to your computer. If you have already put the floppy disk into your system and have entered the Q-Flash utility, please follow the steps below to flash BIOS.

Steps:

1. Press arrow buttons on your keyboard to move the light bar to "Update BIOS from Floppy" item in the Q-Flash menu and press Enter button.
Later, you will see a box pop up showing the BIOS files you previously downloaded to the floppy disk.



If you want to save the current BIOS for backup purpose, you can begin Step 1 with "Save BIOS to Floppy" item.

2. Move to the BIOS file you want to flash and press Enter.

In this example, we only download one BIOS file to the floppy disk so only one BIOS file, 8GE800.F4, is listed.



Please confirm again you have the correct BIOS file for your motherboard.

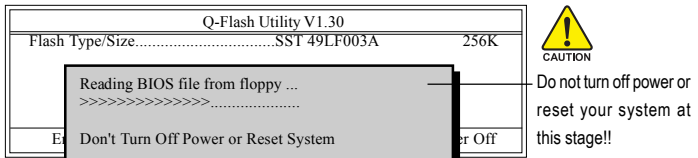
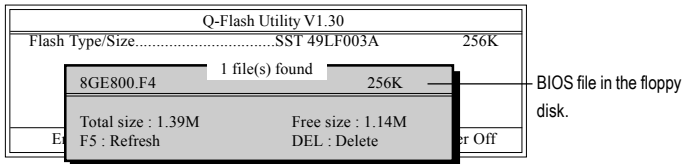

After BIOS file is read, you'll see a confirmation dialog box asking you "Are you sure to update BIOS?"



Please do not take out the floppy disk when it begins flashing BIOS.

- Press Y button on your keyboard after you are sure to update BIOS.
Then it will begin to update BIOS. The progress of updating BIOS will be shown at the same time.

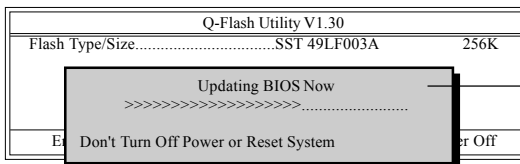

Do not turn off power or reset your system at this stage!!

- Press any keys to return to the Q-Flash menu when the BIOS updating procedure is completed.

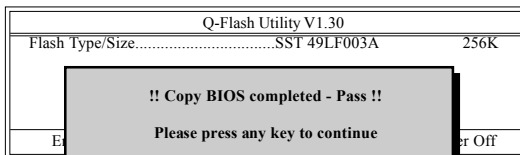

- Press Esc and then Y button to exit the Q-Flash utility. The computer will restart automatically after you exit Q-Flash.

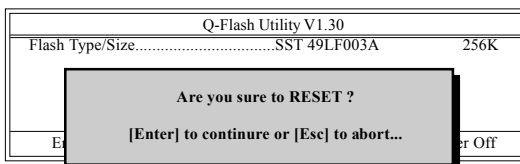

After system reboots, you may find the BIOS version on your boot screen becomes the one you flashed.

The BIOS file becomes F4 after updating

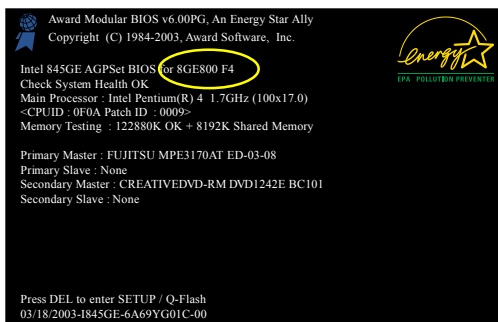

- Press Del to enter BIOS menu after system reboots and "Load BIOS Fail-Safe Defaults". See how to Load BIOS Fail-Safe Defaults, please kindly refer to Step 6 to 7 in **Part One**.

Congratulation!! You have updated BIOS successfully!!

Method 2 : @BIOS™ Utility

If you do not have a DOS startup disk, we recommend that you use the new @BIOS utility. @BIOS allows users to update their BIOS under Windows. Just select the desired @BIOS server to download the latest version of BIOS.

Fig 1. Installing the @BIOS utility

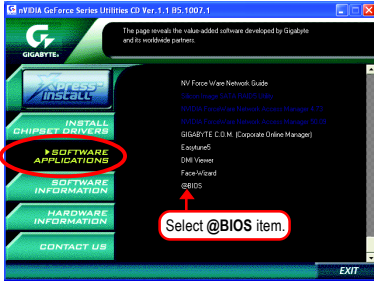

Fig 2. Installation complete and run @BIOS

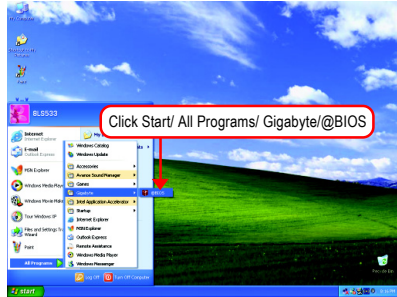

Fig 3. The @BIOS utility

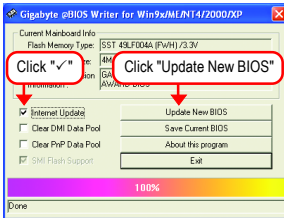
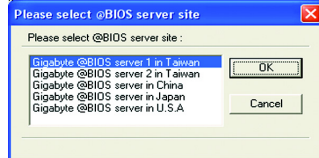

Fig 4. Select the desired @BIOS server



1. Methods and steps:

I. Update BIOS through Internet:

- a. Click "Internet Update" icon.
- b. Click "Update New BIOS" icon.
- c. Select @BIOS™ sever.
- d. Select the exact model name on your motherboard.
- e. System will automatically download and update the BIOS.

II. Update BIOS NOT through Internet:

- a. Do not click "Internet Update" icon.
- b. Click "Update New BIOS".
- c. Please select "All Files" in dialog box while opening the old file.
- d. Please search for BIOS unzip file, downloading from internet or any other methods (such as: K8NF9-2.D1).
- e. Complete update process following the instruction.

III. Save BIOS:

In the very beginning, there is "Save Current BIOS" icon shown in dialog box. It means to save the current BIOS version.

IV. Check out supported motherboard and Flash ROM:

In the very beginning, there is "About this program" icon shown in dialog box. It can help you check out which kind of motherboard and which brand of Flash ROM are supported.

2. Note:

- I. In method I, if it shows two or more motherboard's model names to be selected, please make sure your motherboard's model name again. Selecting wrong model name will cause the system unbooted.
- II. In method II, be sure that motherboard's model name in BIOS unzip file are the same as your motherboard's. Otherwise, your system won't boot.
- III. In method I, if the BIOS file you need cannot be found in @BIOS™ server, please go onto Gigabyte's website for downloading and updating it according to method II.
- IV. Please note that any interruption during updating will cause system unbooted.
- V. Do not use @BIOS and C.O.M. (Corporate Online Management) at the same time.

4-1-4 Configuring SATA Hard Drive(s)

To configure SATA hard drive(s), follow the steps below:

- (1) Install SATA hard drive(s) in your system.
- (2) Configure SATA controller mode and boot sequence in BIOS Setup.
- (3) Configure RAID set in RAID BIOS.^(Note)
- (4) Make a floppy disk containing the SATA controller driver.
- (5) Install the SATA controller driver during OS installation.

Before you begin

Please prepare:

- (a) Two SATA hard drives (to ensure optimal performance, it is recommended that you use two hard drives with identical model and capacity). If you do not want to create RAID with the SATA controller, you may prepare only one hard drive.
- (b) An empty formatted floppy disk.
- (c) Windows XP/2000 setup disk.
- (d) Driver CD for your motherboard.

(1) Install SATA hard drive(s) in your system

Attach one end of the SATA signal cable to the rear of the SATA hard drive and the other end to available SATA port(s) on the motherboard. On the GA-K8NF-9(rev. 2.2) motherboard, connect the SATA cable to the SATAII0_1/SATAII2_3 connector. Then connect the power connector from your power supply to the hard drive.

(Note) Skip this step if you do not want to create RAID array on the SATA controller.

(2) Configuring SATA controller mode and boot sequence in BIOS Setup

You have to make sure whether the SATA controller is configured correctly in system BIOS Setup and set BIOS boot sequence for the SATA hard drive(s).

Step 1:

Turn on your computer and press Del to enter BIOS Setup during POST (Power-On Self Test). In the example in Figure 1, make sure that **NV Serial-ATA 1** or **NV Serial-ATA 2** under the **Integrated Peripherals** menu is enabled (**NV Serial-ATA 1** controls the SATAII0_1 connectors and **NV Serial-ATA 2** controls the SATAII2_3 connectors). If you want to create RAID, set the **NV IDE/SATA RAID function** item to **Enabled** (Disabled by default) (Figure 1). Set the **NV IDE/SATA RAID function** item to **Disabled** if you do not want to create RAID.

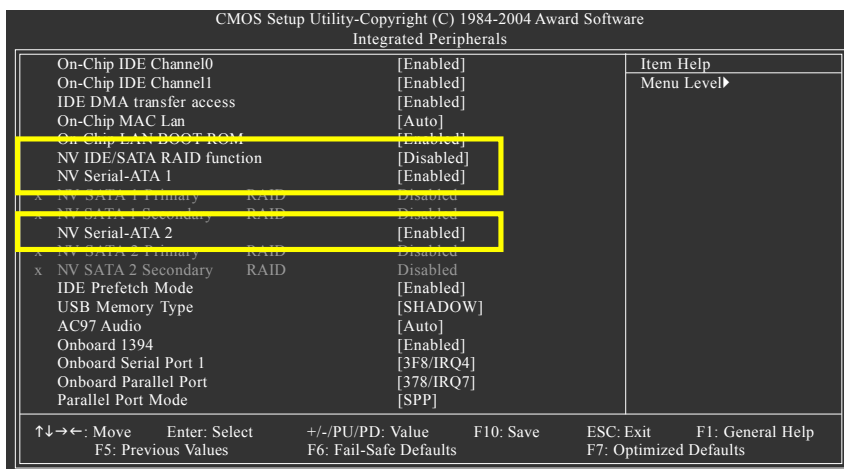

Figure 1



NOTE The BIOS Setup menus described in this section may not show the exact settings for your motherboard. The actual BIOS Setup menu options you will see shall depend on the motherboard you have and the BIOS version.

Step 2:

If you do not create RAID, select **Hard Disk Boot Priority** under the **Advanced BIOS Features** menu. In the **Hard Disk Boot Priority** submenu, select the model of the SATA hard drive onto which you wish to install Microsoft Windows 2000/XP. You should see a screen similar to Figure 2 below.

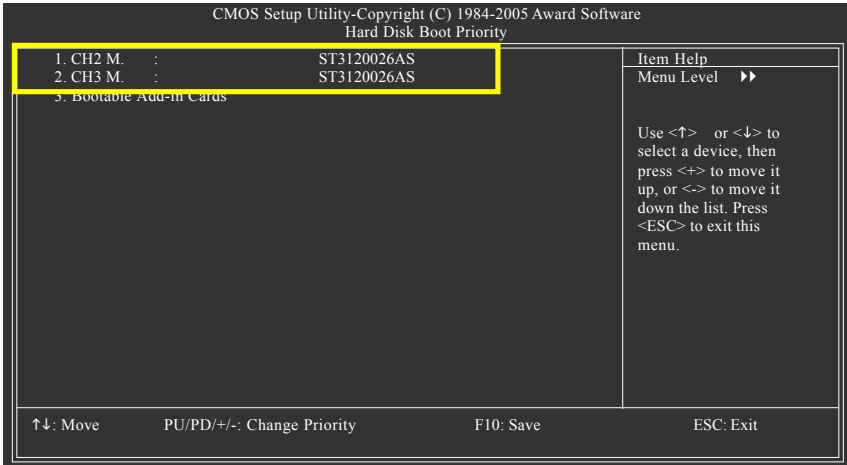

Figure 2

After configuring the SATA controller mode in system BIOS, if you wish to create RAID, save the settings and exit. Then go to RAID BIOS (refer to **(3)Configure RAID set in RAID BIOS** section) to configure the RAID array. After finished, re-enter the system BIOS Setup to set hard disk boot priority before OS installation. Select **Hard Disk Boot Priority** under the **Advanced BIOS Features** menu. In the **Hard Disk Boot Priority** submenu, select the RAID array onto which you wish to install Microsoft Windows 2000/XP (Figure 3).

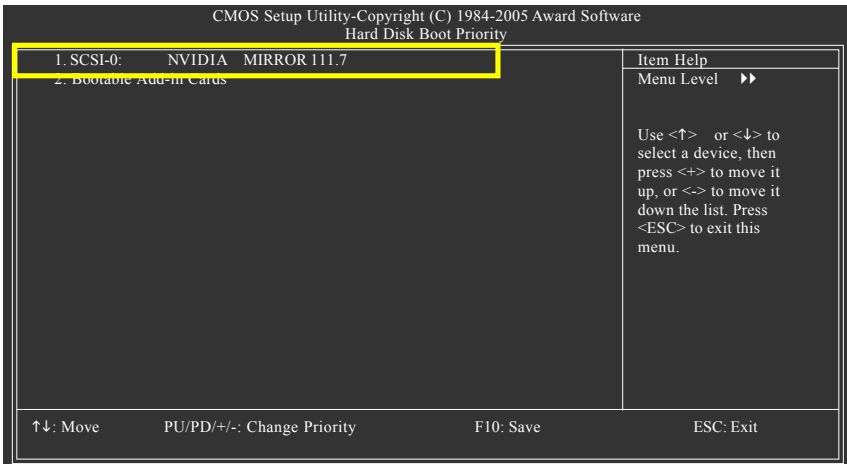

Figure 3

Step 3:

To boot from Windows installation CD-ROM, set **First Boot Device** under the **Advanced BIOS Features** menu to **CDROM** (Figure 4).

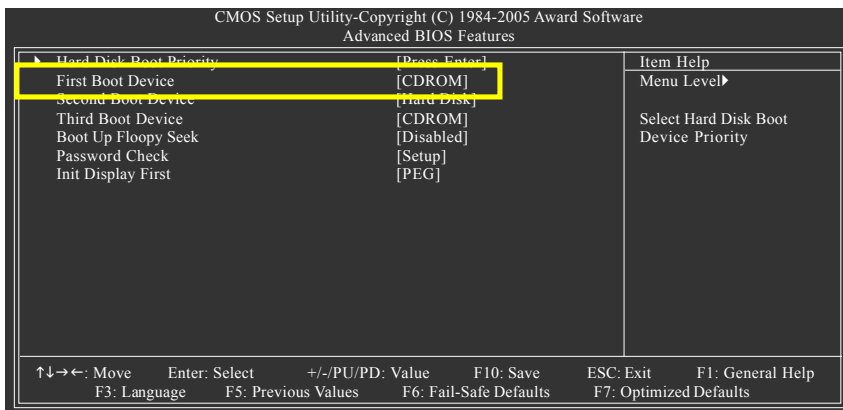

Figure 4

Step 4:

Save and exit BIOS Setup.

(3) Configuring RAID set in RAID BIOS

Enter the RAID BIOS setup utility to configure a RAID array. Skip this step and proceed to Section 4 if you do not want to create RAID.

Step 1:

After the POST memory test begins and before the operating system boot begins, look for a message which says "Press F10 to enter RAID setup utility" (Figure 5). Hit the **F10** key to enter the RAID BIOS setup utility.

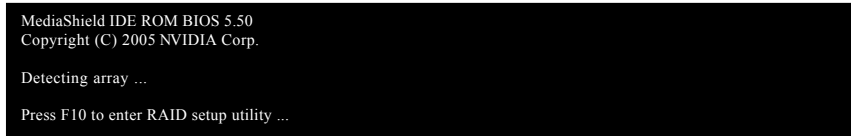

Figure 5

Step 2:

The Define a New Array screen is the first option screen when you enter the NVIDIA RAID setup utility. (Figure 6). You can press the TAB key to highlight through options.

Step 3:

In the RAID Mode field, use the UP or DOWN ARROW key to select a RAID mode. The supported RAID modes include Mirroring (default), Striping, Stripe Mirroring, Spanning. The following is an example of RAID 0 array creation.

Step 4:

If RAID 0 is selected(select Striping in the RAID Mode field), you can manually set the striping block size. In the Striping Block field, use the UP or DOWN ARROW key to set the Striping Block size. The *KB* is the standard unit of Striping Block size. We recommend you leaving it to the default setting--Optimal (64K). The size range is from 4K to 128K.

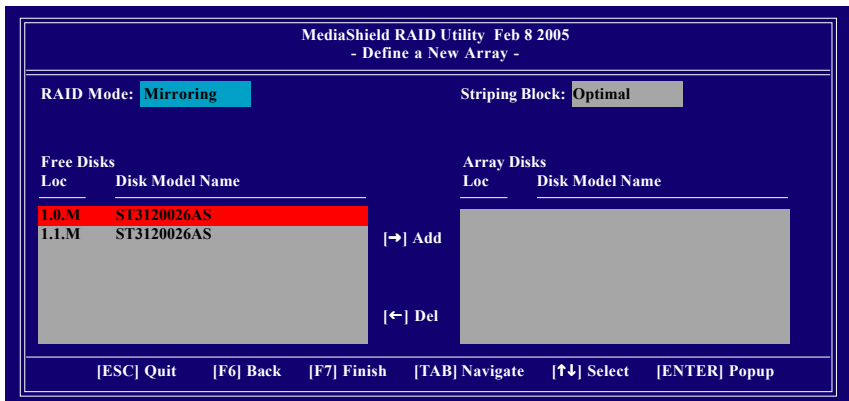

Figure 6

Step 5:

Next, select the hard drives which you wish to be included in the disk array. The Free Disks section displays the information about the currently installed SATA hard drives. Press the TAB key to move to the Free Disks section. Select the target hard drives using the UP or DOWN ARROW key and use the RIGHT ARROW key to add the hard drives to the Array Disks section (Figure 7).

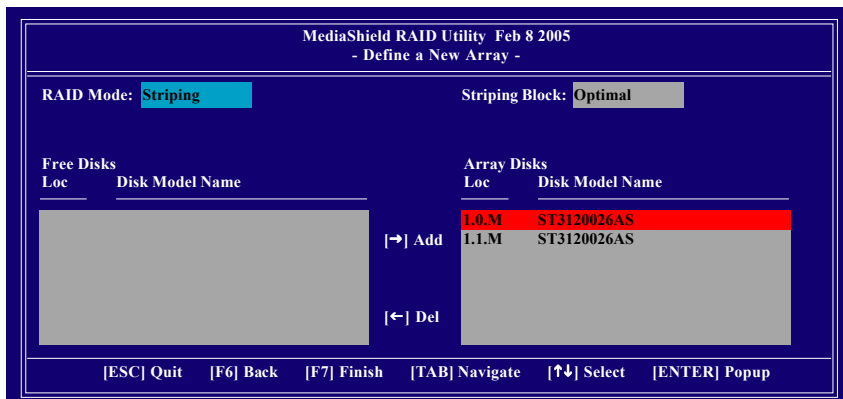

Figure 7

Step 6:

Press F7 after selecting the target hard disks. A message which says "Clear disk data?" will appear (Figure 8). If you are sure to clear the data in the selected hard drives, press Y. (If the hard drives contain previously created RAID array, you need to press Y to clear the data from the hard drives.)

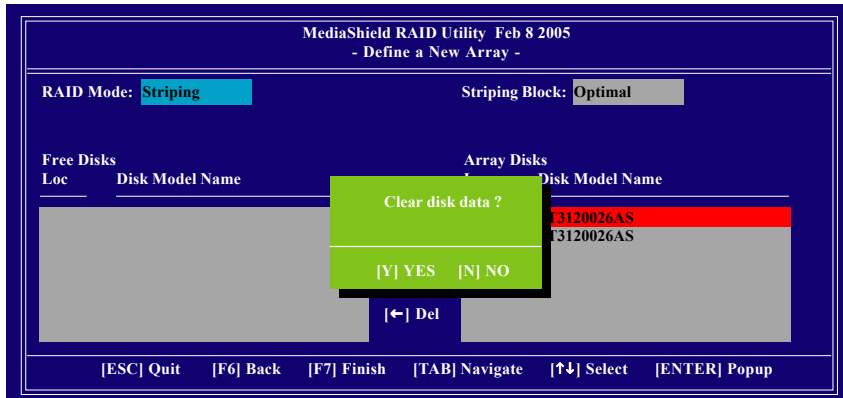

Figure 8

(5) Installing SATA controller driver during OS installation

Now that you have prepared the SATA driver disk and configured BIOS settings, you are ready to install Windows 2000/XP onto your SATA hard drive with the driver. The following is an example of Windows XP installation.

Step 1: Restart your system to boot from the Windows 2000/XP Setup disk and press F6 as soon as you see the "Press F6 if you need to install a 3rd party SCSI or RAID driver" message (Figure 14). After pressing F6, there will be a few moments of some files being loaded before you see the next screen.



Figure 14

Step 2:

When a screen similar to that below appears (Figure 15), insert the floppy disk containing the SATA driver and press S.

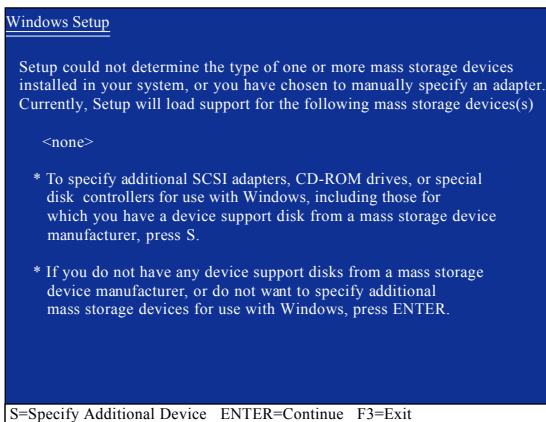

Figure 15

Step 3:

If Setup correctly recognizes the driver in the floppy disk, a controller menu similar to Figure 16 below will appear. Use the ARROW keys to select **NVIDIA RAID CLASS DRIVER**^(Note) (Figure 16) and press ENTER. Later, when a screen similar to Figure 17 appears, you must press S to select additional driver. The screen will return to previous screen as shown in Figure 16. Select **NVIDIA NForce Storage Controller** and press ENTER.

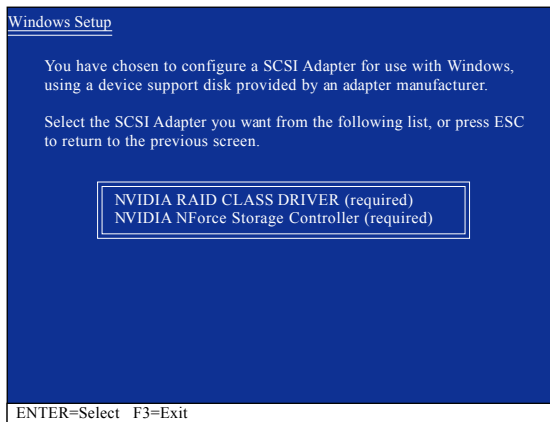

Figure 16

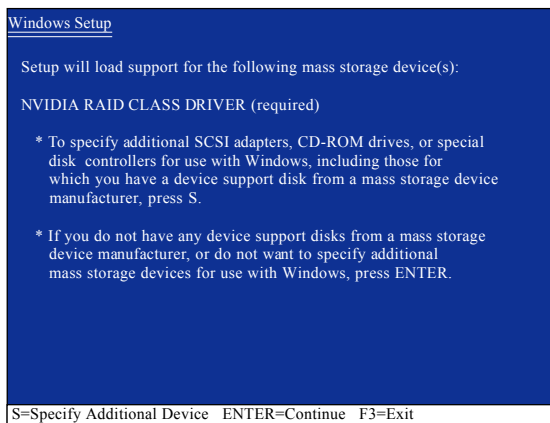

Figure 17



If a message appears saying one or some file(s) cannot be found, please check the floppy disk or copy the correct SATA driver again from the motherboard driver CD.

(Note) If you want to create RAID, select both **NVIDIA RAID CLASS DRIVER** and then **NVIDIA NForce Storage Controller**.

If you do not create RAID, select **NVIDIA NForce Storage Controller** only.

Step 4:

When the next screen (Figure 18) appears, press ENTER to continue the SATA driver installation from the floppy disk.

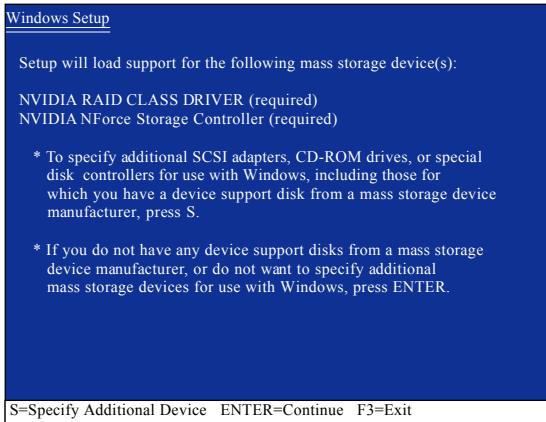

Figure 18

After the SATA controller driver installation is completed, you should see a screen similar to that below. You can proceed with the Windows 2000/XP installation now.

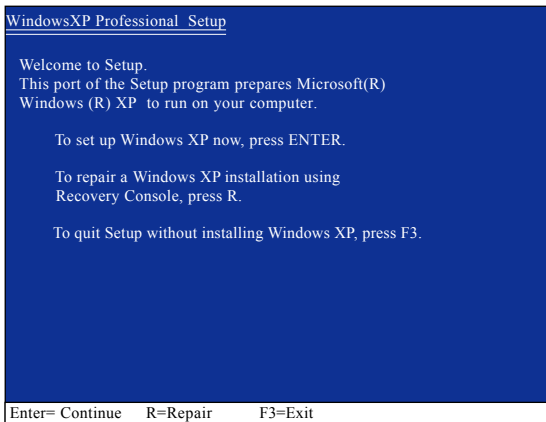

Figure 19

(6) Configuring a bootable RAID array with Microsoft Windows 2000

Problem: Users cannot install Windows 2000 with Service Pack 2 (or previous versions) to a bootable RAID volume.

There are two solutions to resolve this issue.

Solutions 1:

Use the NVRAID tool (nForce Driver Version 5.xx) to convert the boot volume to a RAID array. Here are the detailed step-by-step instructions:

Step 1:

Install Windows 2000 onto a selected hard drive. Download and install Windows 2000 Service Pack 4 from Microsoft's website.

Step 2:

After system restarts, press Del to enter system BIOS Setup during POST (Power-On Self Test). Under the **Integrated Peripherals** menu assure the SATA port connecting the SATA hard disk (the one containing the Windows 2000) is **Enabled** (Figure 20). Save settings and exit the BIOS setup.

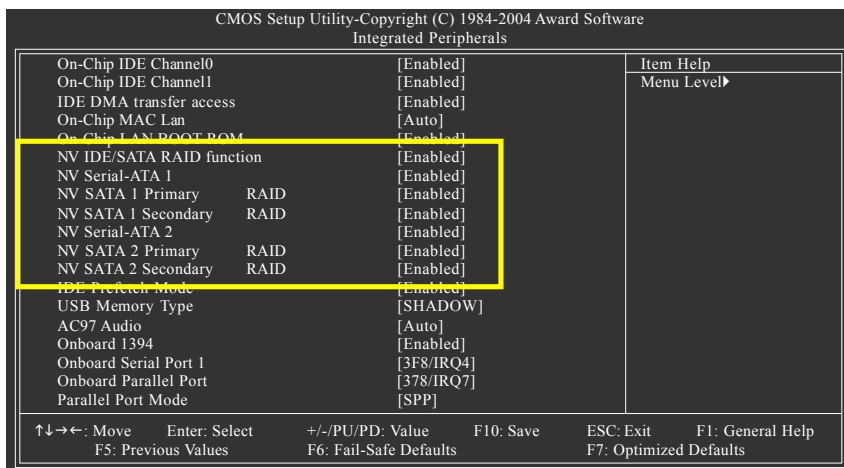

Figure 20

Step 3:

After system restarts, press F10 to enter the NVIDIA RAID setup utility. Select Striping in the RAID Mode field (Figure 21). Move to the Free Disks section with the TAB key. Select the desired disk and use the RIGHT ARROW key to add it to Array Disks menu.

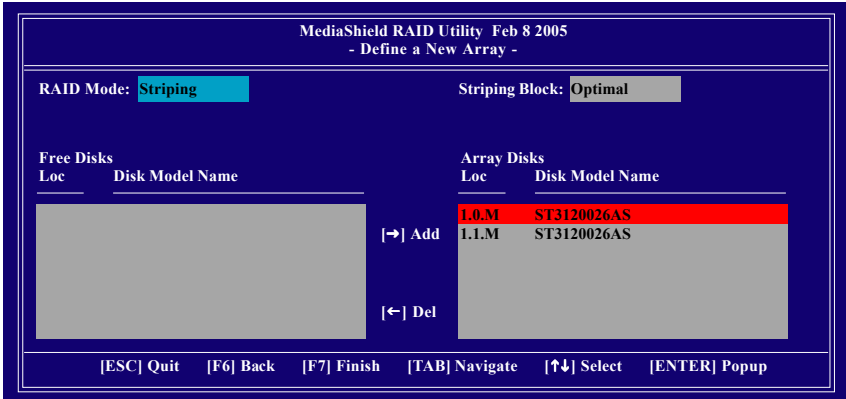

Figure 21

Step 4:

After all the settings, press F7 to complete the configuration. When prompted to **Clear Disk Data** (Figure 22), press N. Then press CTRL+X to exit the NVIDIA RAID BIOS. Restart the computer to boot into Windows 2000.

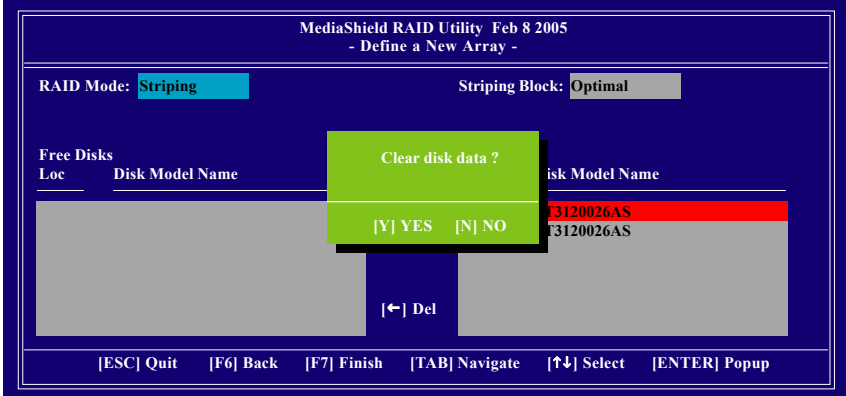

Figure 22

Step 5:

Install the NVIDIA nForce Driver Package while in Windows 2000 and reboot the system. Go to **START> Programs>Nvidia Corporation** and select **NVRAID manager**. You should see the single disk RAID array (in striping mode) that was created from the boot disk. Select the single boot disk RAID Array by clicking on it. Select **Convert Array** under the **System Tasks** and select **Next** following the instructions. Select the desired type of RAID array you want to convert and then select **Next**. You are prompted to select the desired Free Disk(s) to add to the bootable RAID array. Press **Finish** then NVRAID will start converting the single disk RAID array into a multi-disk RAID array in a bootable format.

Note: Conversion may take 1~2 hours depending on disk size.

Solutions 2:

Users must create a combination installation CD that includes Windows 2000 and Service Pack 3 or Service Pack 4 fixes integrated in. To create the combination installation CD, refer to the following website:

<http://www.microsoft.com/windows2000/downloads/servicepacks/sp4/HFdeploy.htm>

Note: If users choose not to install Windows 2000 Service Pack 3 or 4, RAID is still supported on Windows 2000. However, users will not be able to create a bootable RAID volume.

This motherboard provides 6 audio connectors. You are able to use 2-/4-/6-/8-channels audio feature by audio software selection.

Introduction of audio connectors:

You may connect CD-ROM/DVD-ROM, walkman or others audio input to Line In.

The front channels or earphone can be connected to Line Out (Front Speaker Out).

Connect microphone to Mic In.

Connect the rear channels to Rear Speaker Out.

Connect the Center/Subwoofer channels to Center/Subwoofer Speaker Out.

Connect the side channels to Side Speaker Out.

The installation of audio software is very simple. Please follow the steps to install the function. (Following pictures are in Windows XP.)

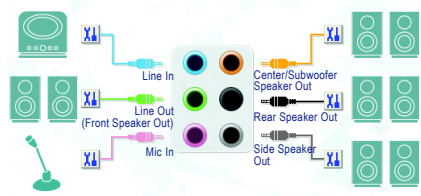

Stereo Speakers Connection and Settings:

We recommend that you use the speaker with amplifier to acquire the best sound effect if the stereo output is applied.

STEP 1:

Connect the stereo speakers or earphone to "Line Out".

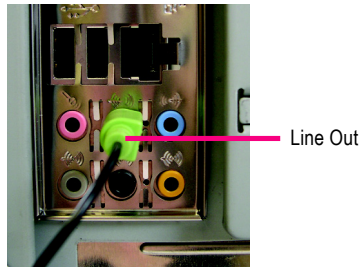

STEP 2:

Following installation of the audio driver, you'll find a Sound Effect  icon on the lower right hand taskbar. Click the icon to select the function.

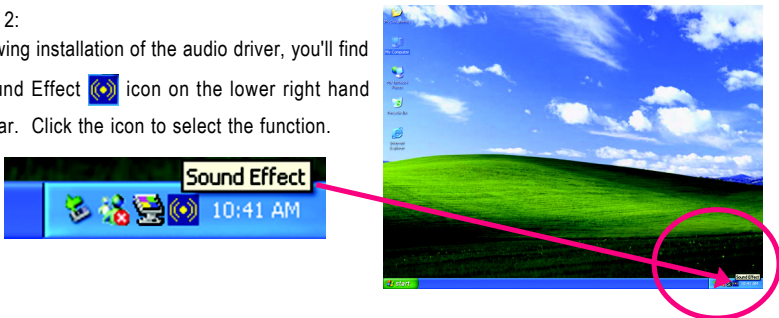

STEP 3:

Click "Speaker Configuration" then click on the left selection bar and select "2CH Speaker" to complete 2 channel audio configuration.

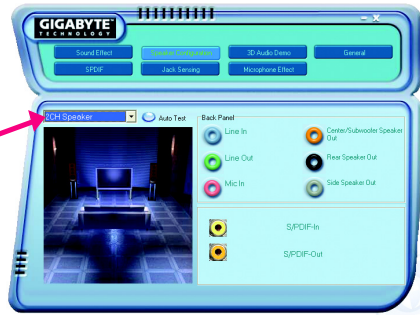
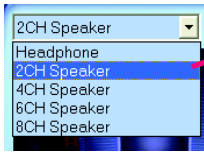

4 Channel Audio Setup

STEP 1:

Connect the front channels to "Front Speaker Out", the rear channels to "Rear Speaker Out".

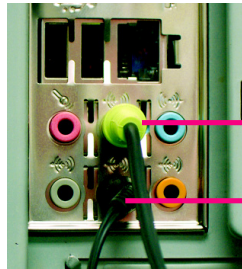

Front Speaker Out

Rear Speaker Out

STEP 2:

Following installation of the audio driver, you'll find a Sound Effect icon on the lower right hand taskbar. Click the icon to select the function.



STEP 3:

Click "Speaker Configuration" then click on the left selection bar and select "4CH Speaker" to complete 4 channel audio configuration.



6 Channel Audio Setup

STEP 1 :

Connect the front channels to "Front Speaker Out", the rear channels to "Rear Speaker Out", and the Center/Subwoofer channels to "Center/Subwoofer Speaker Out".

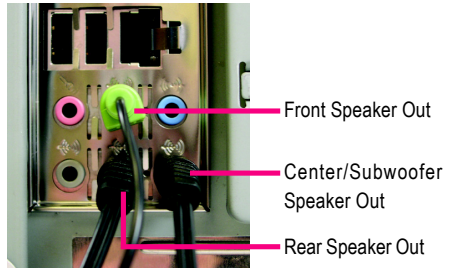

STEP 2:

Following installation of the audio driver, you'll find a Sound Effect icon on the lower right hand taskbar. Click the icon to select the function.

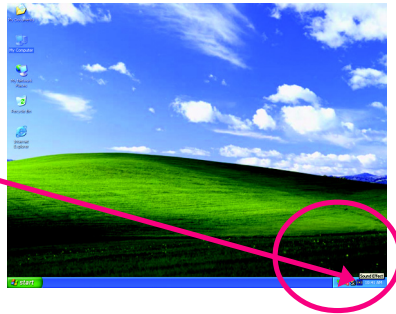

STEP 3:

Click "Speaker Configuration" then click on the left selection bar and select "6CH Speaker" to complete 6 channel audio configuration.

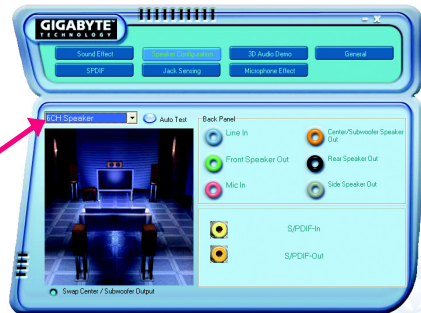
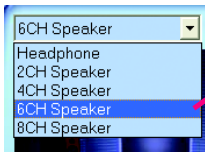

8 Channel Audio Setup

STEP 1 :

Connect the front channels to "Front Speaker Out", the rear channels to "Rear Speaker Out", the Center/Subwoofer channels to "Center/Subwoofer Speaker Out", and the side channels to "Side Speaker Out".

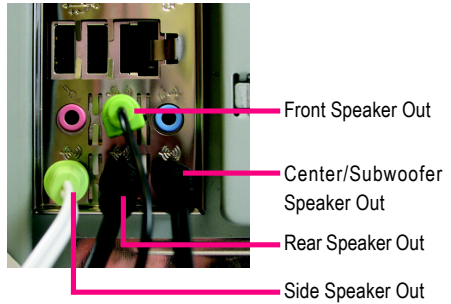

STEP 2 :

Following installation of the audio driver, you'll find a Sound Effect icon on the lower right hand taskbar. Click the icon to select the function.

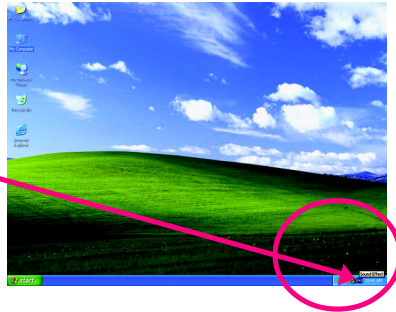

STEP 3:

Click "Speaker Configuration" then click on the left selection bar and select "8CH Speaker" to complete 8 channel audio configuration.



Sound Effect Configuration:

At the sound effect menu, users can adjust sound option settings as desired.

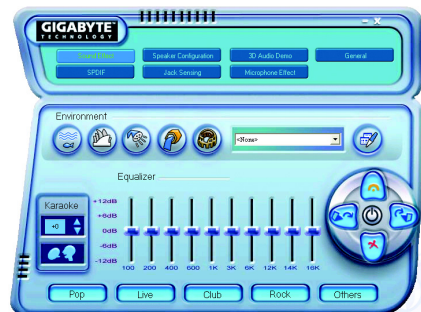

4-2 Troubleshooting

Below is a collection of general asked questions. To check general asked questions based on a specific motherboard model, please log on to <http://www.gigabyte.com.tw>

Question 1: I cannot see some options that were included in previous BIOS after updating BIOS. Why?

Answer: Some advanced options are hidden in new BIOS version. Please press Ctrl and F1 keys after entering BIOS menu and you will be able to see these options.

Questions 2: Why is the light of my keyboard/optical mouse still on after computer shuts down?

Answer: In some boards, a small amount of electricity is kept on standby after computer shuts down and that's why the light is still on.

Question 3: How do I clear CMOS?

Answer: If your board has a Clear CMOS jumper, please refer to the Clear CMOS steps in the manual. If your board doesn't have such jumper, you can take off the on-board battery to leak voltage to clear CMOS. Please refer to the steps below:

Steps:

1. Turn off power.
2. Disconnect the power cord from MB.
3. Take out the battery gently and put it aside for about 10 minutes (Or you can use a metal object to connect the positive and negative pins in the battery holder to makethem short for one minute).
4. Re-insert the battery to the battery holder.
5. Connect power cord to MB again and turn on power.
6. Press Del to enter BIOS and load Fail-Safe Defaults(or load Optimized Defaults).
7. Save changes and reboot the system.

Question 4: Why do I still get a weak sound after turning up the speaker to the maximum volume?

Answer: Please make sure the speaker you are using is equipped with an internal amplifier. If not, please change another speaker with power/amplifier and try again later.

Question 5: Sometimes I hear different continuous beeps from computer after system boots up. What do these beeps usually stand for?

Answer: The beep codes below may help you identify the possible computer problems. However, they are only for reference purposes. The situations might differ from case to case.

→ AMI BIOS Beep Codes

- *Computer gives 1 short beep when system boots successfully.
- *Except for beep code 8, these codes are always fatal.
 - 1 beep Refresh failure
 - 2 beeps Parity error
 - 3 beeps Base 64K memory failure
 - 4 beeps Timer not operational
 - 5 beeps Processor error
 - 6 beeps 8042 - gate A20 failure
 - 7 beeps Processor exception interrupt error
 - 8 beeps Display memory read/write failure
 - 9 beeps ROM checksum error
 - 10 beeps CMOS shutdown register read/write error
 - 11 beeps Cache memory bad

→ AWARD BIOS Beep Codes

- 1 short: System boots successfully
- 2 short: CMOS setting error
- 1 long 1 short: DRAM or M/B error
- 1 long 2 short: Monitor or display card error
- 1 long 3 short: Keyboard error
- 1 long 9 short: BIOS ROM error
- Continuous long beeps: DRAM error
- Continuous short beeps: Power error



Contact Us

- **Taiwan (Headquarters)**

GIGA-BYTE TECHNOLOGY CO., LTD.

Address: No.6, Bau Chiang Road, Hsin-Tien, Taipei 231,
Taiwan

TEL: +886-2-8912-4888

FAX: +886-2-8912-4003

Tech. Support :

<http://tw.giga-byte.com/TechSupport/ServiceCenter.htm>

Non-Tech. Support(Sales/Marketing) :

<http://ggts.gigabyte.com.tw/nontech.asp>

WEB address (English): <http://www.gigabyte.com.tw>

WEB address (Chinese): <http://chinese.giga-byte.com>

- **U.S.A.**

G.B.T. INC.

TEL: +1-626-854-9338

FAX: +1-626-854-9339

Tech. Support :

<http://tw.giga-byte.com/TechSupport/ServiceCenter.htm>

Non-Tech. Support(Sales/Marketing) :

<http://ggts.gigabyte.com.tw/nontech.asp>

WEB address : <http://www.giga-byte.com>

- **Germany**

G.B.T. TECHNOLOGY TRADING GMBH

Tech. Support :

<http://tw.giga-byte.com/TechSupport/ServiceCenter.htm>

Non-Tech. Support(Sales/Marketing) :

<http://ggts.gigabyte.com.tw/nontech.asp>

WEB address : <http://www.gigabyte.de>

- **Japan**

NIPPON GIGA-BYTE CORPORATION

WEB address : <http://www.gigabyte.co.jp>

- **Singapore**

GIGA-BYTE SINGAPORE PTE. LTD.

Tech. Support :

<http://tw.giga-byte.com/TechSupport/ServiceCenter.htm>

Non-Tech. Support(Sales/Marketing) :

<http://ggts.gigabyte.com.tw/nontech.asp>

WEB address : <http://www.gigabyte.com.sg>

- **U.K.**

G.B.T. TECH. CO., LTD.

Tech. Support :

<http://tw.giga-byte.com/TechSupport/ServiceCenter.htm>

Non-Tech. Support(Sales/Marketing) :

<http://ggts.gigabyte.com.tw/nontech.asp>

WEB address : <http://uk.giga-byte.com>

- **The Netherlands**

GIGA-BYTE TECHNOLOGY B.V.

Tech. Support :

<http://tw.giga-byte.com/TechSupport/ServiceCenter.htm>

Non-Tech. Support(Sales/Marketing) :

<http://ggts.gigabyte.com.tw/nontech.asp>

WEB address : <http://www.giga-byte.nl>

- **China**

NINGBO G.B.T. TECH. TRADING CO., LTD.

Tech. Support :

<http://tw.giga-byte.com/TechSupport/ServiceCenter.htm>

Non-Tech. Support(Sales/Marketing) :

<http://ggts.gigabyte.com.tw/nontech.asp>

WEB address : <http://www.gigabyte.com.cn>

Shanghai

TEL: +86-021-63410999

FAX: +86-021-63410100

Beijing

TEL: +86-10-62102838

FAX: +86-10-62102848

Wuhan

TEL: +86-27-87851061

FAX: +86-27-87851330

GuangZhou

TEL: +86-20-87586074

FAX: +86-20-85517843

Chengdu

TEL: +86-28-85236930

FAX: +86-28-85256822

Xian

TEL: +86-29-85531943

FAX: +86-29-85539821

Shenyang

TEL: +86-24-23960918

FAX: +86-24-23960918-809

- **Australia**

GIGABYTE TECHNOLOGY PTY. LTD.

Tech. Support :

<http://tw.giga-byte.com/TechSupport/ServiceCenter.htm>

Non-Tech. Support(Sales/Marketing) :

<http://ggts.gigabyte.com.tw/nontech.asp>

WEB address : <http://www.giga-byte.com.au>

- **France**

GIGABYTE TECHNOLOGY FRANCE S.A.R.L.

Tech. Support :

<http://tw.giga-byte.com/TechSupport/ServiceCenter.htm>

Non-Tech. Support(Sales/Marketing) :

<http://ggts.gigabyte.com.tw/nontech.asp>

WEB address : <http://www.gigabyte.fr>

- **Russia**

Moscow Representative Office Of GIGA-BYTE Technology Co., Ltd.

Tech. Support :

<http://tw.giga-byte.com/TechSupport/ServiceCenter.htm>

Non-Tech. Support(Sales/Marketing) :

<http://ggts.gigabyte.com.tw/nontech.asp>

WEB address : <http://www.gigabyte.ru>

- **Poland**

Office of GIGA-BYTE TECHNOLOGY Co., Ltd. in POLAND

Tech. Support :

<http://tw.giga-byte.com/TechSupport/ServiceCenter.htm>

Non-Tech. Support(Sales/Marketing) :

<http://ggts.gigabyte.com.tw/nontech.asp>

WEB address : <http://www.gigabyte.pl>

- **Serbia & Montenegro**

Representative Office Of GIGA-BYTE Technology Co., Ltd. in SERBIA & MONTENEGRO

Tech. Support :

<http://tw.giga-byte.com/TechSupport/ServiceCenter.htm>

Non-Tech. Support(Sales/Marketing) :

<http://ggts.gigabyte.com.tw/nontech.asp>

WEB address: <http://www.gigabyte.co.yu>

- **Czech Republic**

Representative Office Of GIGA-BYTE Technology Co., Ltd. in CZECH REPUBLIC

Tech. Support :

<http://tw.giga-byte.com/TechSupport/ServiceCenter.htm>

Non-Tech. Support(Sales/Marketing) :

<http://ggts.gigabyte.com.tw/nontech.asp>

WEB address: <http://www.gigabyte.cz>

- **Romania**

Representative Office Of GIGA-BYTE Technology Co., Ltd. in Romania

Tech. Support :

<http://tw.giga-byte.com/TechSupport/ServiceCenter.htm>

Non-Tech. Support(Sales/Marketing) :

<http://ggts.gigabyte.com.tw/nontech.asp>

WEB address: <http://www.gigabyte.com.ro>
